

\$1.00

www.LifestyleStore.com

800-900-6463

2012 CATALOG

**METAL DETECTING-TREASURE HUNTING
GOLD PROSPECTING-ROCK COLLECTING**

GOLD BUDDY

JOBE Tools 



GOLD GENIE

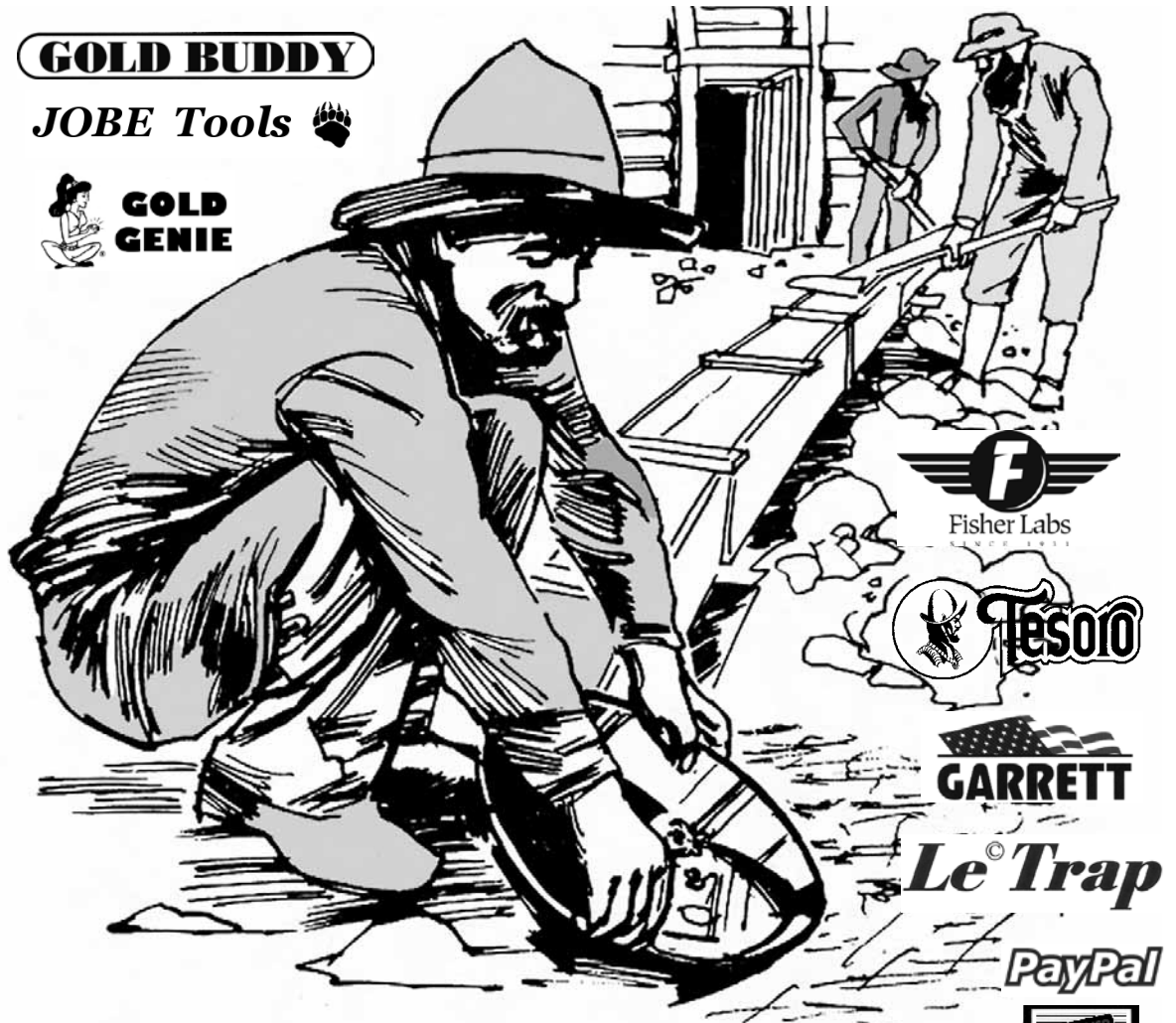

Le Trap

PayPal

541-318-1131

fax 541-318-1381

info@lifestylestore.com

THE Lifestyle STORE

2550 NE Highway 20 Suite 110

Bend, Or 97701

Some items available in limited quantities.
Prices subject to change without notice.



Gold Facts

Symbol=Au

Melting point= 1948 degrees Fahrenheit

Specific gravity is 19.3

Hardness=2.5 on Mohs scale

How Gold Is Measured

Gold, Silver, and other precious metals are universally bought and sold in *Troy ounces*. A Troy ounce is heavier than a standard ounce as there are only 12 troy ounces in a pound. Troy ounces are usually subdivided into either *Pennyweights*, abbreviated (*dwt*), or *Grains*. Professional gold dealers prefer grams but pennyweights are preferred by gold prospectors.

In the pennyweight system each Troy Ounce is divided into 20 units called Pennyweights and each pennyweight is further divided into 24 *grains*. Therefore one troy ounce is equal to 480 grains. This is the same system used in measuring gunpowder and probably accounts for the popularity of the pennyweight system. Most of the early prospectors had no idea what a gram was but they all had a gun powder scale that was calibrated in grains.

The metric system is easy to use because all you need to remember is that one troy ounce is 31.1 grams. Since this is based on the metric system grams are simply divided into 1/10th or 1/100th units.

When you are buying or selling gold you must be careful when talking to someone about a quantity of gold. Make sure that the ounces you are talking about are the same ounces you are thinking about. Here are a few conversions to help you keep this straight.

One Troy lb (pound)=12 troy ounces

One troy oz=20 pennyweight (dwt)

One pennyweight = 24 grains

One troy oz=480 grains

One troy oz=31.1 grams

Tips on digital scales

Digital scales are widely available today that are inexpensive and very accurate. These scales can be easily adjusted to weigh in several formats including grams and pennyweights. If you are using one of these scales you need to be sure that the scale is set to use the format you prefer. Areas of potential confusion include the way some scales abbreviate grams and grains, and the similarity of troy and regular ounces. Be sure you check to see that you and your scale are on the same page.

If you are using the gram format it is easy to do a quick check of the format selection and the calibration of the scale by weighing a \$1.00 bill or a nickel. The \$1.00 bill should weigh almost exactly one gram and the nickel should weigh almost exactly five grams.

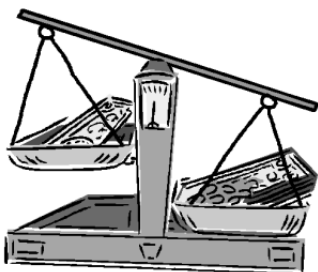

2

Shipping Cost Calculator

Use the following table to calculate shipping cost for standard UPS Ground service in the continental US.

| ORDER TOTAL | ADD FOR SHIPPING |
|-------------------|------------------|
| LESS THAN \$10 | \$7.00 |
| \$10 to \$19.99 | \$8.95 |
| \$20 to \$39.99 | \$10.95 |
| \$40 to \$59.99 | \$12.95 |
| \$60 to \$79.99 | \$14.95 |
| \$80 to \$99.00 | \$15.95 |
| \$100 to \$199.00 | \$22.95 |
| \$200 to \$299.95 | \$29.95 |
| \$300 to \$499.95 | \$34.95 |
| \$500 to \$699.95 | \$44.95 |
| \$700 to \$999.95 | \$59.95 |
| \$1000 & over | Free |

FREE UPS GROUND SHIPPING
for Orders Totaling over \$1000.

Hardness of Minerals

In terms of reliability, hardness is one of the better physical properties for minerals. Specimens of the same mineral may vary slightly from one to another, but generally they are quite consistent. Inconsistencies occur when the specimen is impure, poorly crystallized, or actually an aggregate and not an individual crystal.

Hardness is one measure of the strength of the structure of the mineral relative to the strength of its chemical bonds. Minerals with small atoms, packed tightly together with strong covalent bonds throughout tend to be the hardest minerals. The softest minerals have metallic bonds or even weaker van der Waals bonds as important components of their structure. Hardness is generally consistent because the chemistry of minerals is generally consistent.

Hardness can be tested through scratching. A scratch on a mineral is actually a groove produced by microfractures on the surface of the mineral. A mineral can only be scratched by a harder substance. A hard mineral can scratch a softer mineral, but a soft mineral can not scratch a harder mineral (no matter how hard you try). Therefore, a relative scale can be established to account for the differences in hardness simply by seeing which mineral scratches another. That is exactly what French mineralogist Friedrich Mohs proposed almost one hundred and seventy years ago. The Mohs Hardness Scale starting with Talc at 1 and ending with Diamond at 10, is universally used around the world as a way of distinguishing minerals. Simply put, the higher the number, the harder the mineral.

The Mohs Hardness Scale

| | | |
|----|-----------------------------|---------------------------------------|
| 1 | Talc | |
| 2 | Gypsum | |
| 3 | Calcite | Use the following for a scratch test. |
| 4 | Fluorite | Your Fingernail 2.5 |
| 5 | Apatite | Old Copper Penny 3.5 |
| 6 | Orthoclase | Knife Blade 5.5 |
| 7 | Quartz | Steel File 6.5 |
| 8 | Topaz | |
| 9 | Corundum (Ruby & Sapphire) | |
| 10 | Diamond | |

CATALOG INDEX

| | | | |
|---------------------|-------|------------------------|-------|
| BLACK SAND MAGNETS | 33 | HOSE | 50 |
| BLUE BOWL | 41 | MAGNETS | 32-33 |
| BOOKS: | | MAGNIFIERS | 6-8 |
| CHILDREN | 28 | MAPS | 51-52 |
| DRYWASHING | 36 | MAP SCALES | 52 |
| DOWSING | 66 | METAL DETECTORS & ACC. | 54-64 |
| GEOLOGY | 23 | MINERAL IDENTIFICATION | 21 |
| GHOST TOWNS | 53 | MINERAL SPECIMENS | 21 |
| HOW TO FIND GOLD | 14-15 | MINERS MOSS | 48 |
| LAPIDARY | 25 | MINING CLAIMS | 33 |
| METAL DETECTING | 65-66 | MORTARS | 31 |
| METEORITES | 66 | ORDER FORM | 67 |
| MINERAL ID | 21 | POWER SLUICES | 41-46 |
| ROCK COLLECTING | 26-28 | PUMPS | 49-50 |
| WHERE TO FIND GOLD | 22-23 | SCALES | 3 |
| WHERE TO FIND ROCKS | 26-28 | SCOOPS | 61-63 |
| CLASSIFIERS | 20 | SLUICES & ACC | 42-48 |
| CLEAN UP TOOLS | 38-41 | SNAKE PROTECTION | 29 |
| COMPASSES | 52 | SNIPING STUFF | 32 |
| DISPLAYS | 10-12 | SNUFFER BOTTLE | 12 |
| DREDGES | 45-48 | SPIRAL GOLD WHEELS | 38-40 |
| DRY WASHERS | 34-36 | SURVIVAL | 29 |
| EMERGENCY | 29 | T-SHIRTS | 4 |
| FOR FUN | 4-5 | TOOLS | 30-33 |
| GOLD PANS | 16-19 | TUMBLERS | 24-25 |
| GOLD TESTING | 9 | 12 VOLT ACCESSORIES | 37 |
| GOLD WHEELS | 38-40 | U. V. LIGHTS | 8-9 |
| HEADPHONES | 63 | VACUUMS | 37 |
| HATS | 13 | VIALS | 12 |
| HIGHBANKER | 41-46 | | |



SCALES

Calibration
Weight
Not Included



Triton T2 120 Gram Digital Scale

The Triton T2 has a capacity of 120 grams and reads in 0.1g increments. The protective hinged cover doubles as an expansion tray. Batteries are included. Lifetime / 30 year best-in-industry warranty. Large easy to read LCD display, and three soft rubber keys combined with the unique hinged - yet removable cover make this scale a true winner. The case is ribbed to prevent the scale from slipping out of your hands during use. #-6982

Backlit Display **\$19.95**
1/10th Gram Accuracy
Uses 3 AAA Batteries (included)
Weighs in Grams, Ounces, Troy Ounces & Pennyweights
Calibrate with optional 100 Gram Weight
Hinged Cover Serves as a Weighing Tray
Full Tare Function
30 Year Warranty

Jennings HP-100X Digital Scale



Pocket digital scale for weighing gold, gems, and jewelry. Weighs up to 100 grams with 1/100th gram accuracy in grains, carats, grams, and ounces. Includes a back light, parts counting function, tare function, and auto-off. This scale has a 20 year warranty and includes batteries.

msrp \$89.95 #-5655

\$59.95

1/100th Gram Accuracy **30 Second Auto Off**
Backlit Display **20 Year Warranty**
Full Range Tare Function
Auto Calibration & Auto-Off
Uses 2 AAA Batteries (included)
Weighs in Carats, Grains, Grams, & Ounces

JENNINGS Digital Scale with Extreme Accuracy JS-VG 20

2/1000th Gram Accuracy

This is the perfect compact digital scale for weighing gold, gems, and jewelry. Weighs up to 20 grams with 2/1000th gram accuracy. Weighs in grams, grains, carats, pennyweights, milligrams, ounces and troy ounces. Includes a back light, parts counting function, tare function, and auto-off. This scale has a 20 year warranty and runs on 3 AAA batteries which are included. msrp \$139.95



#-6988

20 Year Warranty

Jewelry Box Style Storage Case, Calibration Weight, and Weighing Tray are Included

\$99.95

Precision Calibration Weights. #-6978 **50 Grams** **\$3.95**
 Use these calibration weights on #-6973 **100 Grams** **\$4.95**
 balance type scales or for calibration #-6976 **200 Grams** **\$5.95**
 of digital scales.



WEIGHING BOATS

These small plastic weighing boats are perfect for weighing small pieces of gold or gem stones. They are 1 3/4 x 2 1/4 inches and come in a pack of 5.

#-6618 **5 pack \$1.00**



Just For Fun

DONKEY CIGARETTE DISPENSER

The old prospectors dream, a donkey laden with cigarettes hidden in his pack. When you push his ears down he calmly lifts his tail and ejects one cigarette from his business end. This little guy is made of plastic and stands 5 inches high and is 8 inches long. A practical cigarette dispenser and everyone around will crack up when the cigarette appears. Individually gift boxed. #-6203

\$12.95



Prospector's Door Knocker

This antiqued cast iron door knocker depicts an old prospectors shovel. It is 8 inches tall and 2 inches wide. It can also be used as a note holder.

#-5601 **\$7.95**



T-Shirts & Stainless Steel Mugs

- ☞ PROSPECTOR T-SHIRTS ARE HANES BEEFY-TEES AND ARE MADE OF 100% PRESHRUNK COTTON
- ☞ MADE IN THE U.S.A.
- ☞ MEDIUM, LARGE, X LARGE, XX LARGE
- ☞ SHIRT COLOR IS ASH GRAY



OLD PROSPECTORS NEVER DIE

#-5608 M,L,XL **\$16.95**
 #-5609 XXL **\$19.95**



IN GOLD WE TRUST

#-6130 M,L,XL **\$16.95**
 #-6132 XXL **\$19.95**



HOW THE WEST WAS WON

#-6078 M,L,XL **\$16.95**
 #-6079 XXL **\$19.95**

16 Ounce Double Walled Stainless Steel Travel Mug

These quality stainless steel travel mugs are double walled for maximum insulation. They have a snug fitting spill-proof plastic lid with a slide cover over the drinking port. They are available in all the same graphics as the shirts illustrated above.

- #-6141 "How The West Was Won"
- #-6143 "Old Prospectors Never Die"
- #-6144 "In Gold We Trust"

\$14.95



Gold Panner Hood Ornament

This very detailed depiction of an old gold prospector panning for gold is fine cast in poly-resin and then dual level electroplated with real brass. An antique patina is added to give the piece the quality metal finish of ancient bronze. Stands about four inches tall with a one inch long bolt extending from the bottom of the sculpture so that it can be attached to a base or used as a hood ornament.

#-6124 **\$29.95**

Small Stone Mortar and Pestle



We have these stone mortar and pestles beautifully crafted in Pakistan out of Fossil Stone, Picture Jasper and Onyx. There are two sizes. The smaller mortars are 3 inches in diameter and 3 inches tall. The larger mortars are 4 inches in diameter and 3 1/2 inches tall.

- #-2403 Small Picture Jasper **\$13.95**
- #-2404 Small Fossil Stone **\$13.95**
- #-2405 Small Onyx **\$13.95**
- #-2409 Large Picture Jasper **\$19.95**
- #-2410 Large Fossil Stone **\$19.95**
- #-2411 Large Onyx **\$19.95**

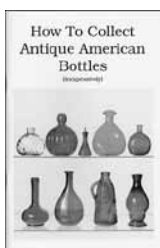

KOVELS' BOTTLES Price List 13th Edition

More than 12,000 new appraiser-approved prices. A 16 page color insert and over 350 black-and-white photographs cover bottles from the 1700s forward. Ralph Kovel, 239 pages, 8x5 inches with a soft cover.

#5388 **\$16.95**

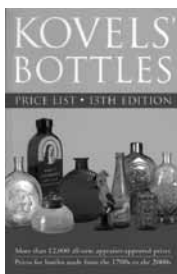

Warman's Civil War Collectables Field Guide: A

guide you can really carry along to auctions and estate sales containing hundreds of photos to make on the spot appraisals of Civil War Collectables. 1,500 listings with 350 color photos. #-1010 **\$12.99**



ANTIQUe MINING EQUIPMENT and Collectables:

This book is a must for those interested in the realities of Gold Rush life, shown in over 450 color photographs Mining stock certificates, currency and newspapers from the day are also shown, along with antique mining tools—all with current values provided for collectors. By David W. Pearson, 8 1/2" x 11" with 225 photos, 173 pages soft cover. #-1001 **\$29.95**

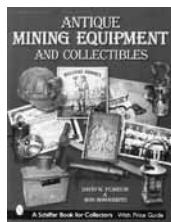

GOLD PANNER BUCKLE

This attractive pewter belt buckle features an old prospector with his gold pan, mule and tools in raised relief. Buckle is natural pewter color, 3 1/2 inches long and 2 inches high. #-6354 **\$12.95**



Mining in the Old West: This fantastic book goes into great detail about the real lives of the brave '49ers and those who followed them, facing unbelievable hardships in the hopes of striking it rich—finding the Mother Lode. Significant mines in California, Nevada, Utah, Oregon, Washington, Montana, Wyoming, South Dakota, Idaho, Colorado, and Arizona are all discussed. This book is a must for those interested in the realities of Gold Rush life, shown in over 300 period photographs. By Sandor Demlinger, 8 1/2" x 11" with 225 photos, 175 pages soft cover. #-6035 **\$29.95**



Overstreet ID and Price Guide to Indian Arrowheads: Twelfth Edition:

The most comprehensive book of its kind. Over 12,000 actual size photographs with 440 full color images. A special section on how to identify and grade your points. This definitive guide has become the number one reference in the field for collectors and dealers. Robert Overstreet, 1232 pages, 9 x 6 inches with a soft cover. #-1012 **\$32.95**

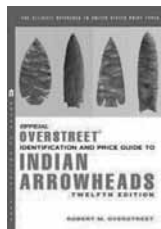

DIAMOND CUT PEWTER GOLD PANNER KEY HOLDER

Pewter raised relief depiction of an old prospector panning for gold. #-6350 **\$5.95**



Prospector Key Chain

Polished stainless steel key chain with an old prospector. Gift boxed. #-6355 **\$3.95**



A Guide Book of United States Coins for 2012: 65th Edition

This is a 2012 fully illustrated catalog and retail valuation list of United States coins from 1616 to date. The only coin-price book with full-color photographs of actual coins. R. S. Yeoman, spiral bound, soft cover, size is 5" x 7 1/2" with 432 pages. #-3501 **\$14.95**



Coin Clinic 2: 1001 More Frequently

Asked Questions World famous numismatist Alan Herbert has 1001 answers to new questions from his "Coin Clinic" column. Altered coins, appraisals, auctions, proofs, and 50 other categories. From the routine to the unusual, every topic will expand your knowledge of the art of buying and selling coins and paper currency. #-3499 **\$12.95**



GOLD IN THE ANCIENT WORLD

The story of how gold influenced the rise and fall of civilizations. The Greeks, Egyptians, Phoenicians, and Romans all valued gold for its beauty and lasting values. A fascinating read for anybody who has fallen under the spell of gold for any reason. Jennifer Mark, 8 1/2 x 5 1/2, 280 pages with a soft cover. #G-1546100 **\$15.95**

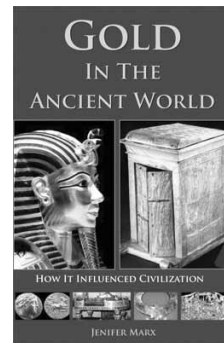

MAGNIFIERS

CAP STYLE MAGNIFIER

These cap style magnifiers have a one size-fits-all velcro style closure to firmly but comfortably attach the magnifier to your head for hands free work. Lenses are crystal clear light weight acrylic. Cap style magnifiers have a fixed standard three dimensional lens and a fold-in fold-out snap action secondary lens. Perfect for working with fine gold, jewelry, examin-



ing ore specimens or any close up work where hands free magnification is required. Can be worn with or without glasses. The primary lens has a 1.8 X magnification, second lens brings the total magnification to 2.3 X, and an additional one inch round magnifier swings down to provide a total possible magnification of 3.7 X or 4.8 X. Weighs approx. 110 grams.
#-5190 **\$9.95**



Cap Style LED Lighted Magnifier

These cap style magnifiers are the same as above except they are lighted by two LED lights. Weighs about 7 ounces and uses 4 AAA batteries, which are not included.
#-5763 **\$12.95**

20 X Key Chain Microscope

This is a surprisingly clear 20 x pocket-microscope that is only 1 1/2 inches long. The body is made of plastic with glass lenses.

#-5683
\$4.95



BASIC 10 X LOUPE

Folds into protective metal cover. 1/2" diameter glass lens.
#-5631 **\$4.95**



10 x 17 mm FOLDING LOUPE

Very good quality folding 10 x loupe with a glass lens and polished metal body / cover.
#-5658
\$9.95



10 x 50mm MAGNIFIER

Extra large black plastic pocket magnifier with a 10 power 50 mm glass lens. A little on the large size for a pocket magnifier but gives a large clear field of view at 10 power.
#-6385 **\$5.95**



2 Inch FOLDING MAGNIFIER with 6 X Lens

This 2 inch, 6 power glass lens folds into a protective plastic case. Gives a wider and clearer field of view than smaller magnifiers with a smaller lens. #-6386 **\$5.95**



Handy Pocket Magnifiers

Folding power magnifier with two 5x glass lenses. The 5x lenses swing out of the protective plastic case individually, or if used together give 10x magnification. #-5630 **\$5.95**



Same as above except three 5x lenses can be used as 5, 10, or 15 power.



#-6000
\$6.95

JOBE QUALITY MAGNIFIERS

These JOBE pocket magnifiers feature quality polished glass Triplet Lenses in a polished metal housing with a sturdy leather protective case.

Triplet Lens Design:

A triplet lens is an optical device consisting of three single lenses. The triplet design is the simplest to give the required number of degrees of freedom to allow the lens designer to overcome all Seidel aberrations. Aberration leads to blurring of the image produced by an image-forming optical system.

Typical Triplet Lens System

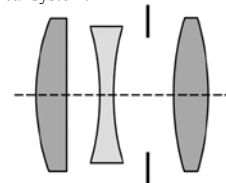

JOBE 10 x 18 mm Triplet

Three element 10 power 18 mm jewelers loupe in a polished metal housing with a leather case.

#-5040 **\$24.95**



JOBE 10 x 21 mm Triplet

Three element 10 power 21 mm jewelers loupe in a polished metal housing with a leather case. #-5635 **\$27.95**

JOBE 20 x 21 mm Triplet

Three element 20 power 21 mm jewelers loupe in a polished metal housing with a leather case. #-5636 **\$29.95**

JOBE 10X and 20X Triplet Jeweler's Loupe

This is a very nice pocket Jeweler's Loupe with an 18 mm, 10 x triplet lens, and a 12 mm, 5 element 20 x lens in a leather case. Both magnifiers are contained in a chrome plated steel protective housing with glass lenses. #-5633 **\$34.95**



JEWELERS EYE LOUPE

Economy 10 x aluminum jewelers loupe has glare reducing powder coated interior and a glass lens.
#-5585 **\$3.95**



3 PIECE SET

Same as above except this 3 piece set includes a 3X, 5X and 10X loupe.
#6824 **\$5.95**



LED JEWELERS EYE LOUPE

10 x jewelers eye loupe with a glass lens. It has an attached LED light that is adjustable to focus the light on the subject. The LED light is powered by a button style battery which is included.
#-5762 **\$5.95**



TRADITIONAL STYLE HAND MAGNIFIERS

The larger magnifier has a 4 inch, 3 X glass lens. The overall length of the magnifier is over 7 inches.

#-5716

\$3.95

The smaller magnifier has a 2 1/2 inch, 5 X glass lens. The overall length is over 4 inches.

#5701

\$2.49



MAP MAGNIFIERS

Credit Card Magnifier

Credit card size plastic magnifier with protective plastic cover.

#-5634 **\$.99**



FULL SHEET MAGNIFIER

Same type of plastic magnifier as above but much larger. 10 inches X 7 inches brings all details in clearly when working with large maps. #-5637 **\$2.49**

30 X LIGHTSCOPE

A precision illuminated pocket microscope with 30 X magnification. Focus can be adjusted by turning the wheel and the retractable condenser lens pinpoints the light on the object. Protective carry case is included. Light-Scope is 5 1/2 inches long, 2 inches high and 7/8 of an inch deep. Made in China. Uses two AA batteries which are not included.
#-5117 **\$20.95**



60-100 X VARIABLE LIGHT SCOPE

A precision illuminated pocket microscope with 60 to 100 variable magnification. Focus can be adjusted by turning the wheel and the light pivots to point at the object. Protective carry case included. Uses 2 AA batteries which are not included. Made in China.
#-5679 **\$26.95**



Swing Arm Lamp/Magnifier

Spring suspension system for adjusting to any position. Arm height adjusts to 36" maximum. There is a 4" diameter optically fine-ground 3-diopter glass lens with 1-3/4" magnification. Includes a metal clamp for attachment. Takes a 60W bulb (not included).
#-6368 **\$24.95**



4 inch 3 x Magnification

Eyesight Protective Magnifying Table Lamp

The intelligent integration of optics and lighting. A flexible neck fluorescent desk lamp with an integrated 3 1/2 inch glass lens 5 x magnifier. The magnifying lens is covered by a hinged cap.
#-6367 **\$29.95**



Large 4X LED Illuminated Magnifier

Powered by 2 AA batteries this hand held magnifier is perfect for working with maps or just about any application where you need a large magnifier. The glass lens is a little over 3 inches square. The body swivels 60 degrees for a comfortable viewing angle. Batteries are not included. #-5765 **\$12.95**



4X LED

4 LED

60 DEGREE

MAGNIFIERS WITH ULTRAVIOLET LIGHTS

40 X 25 mm Loupe

UV Illuminated Magnifier

These pocket sized magnifiers are illuminated by two white LEDs and one Ultraviolet LED. You select the type of light that you want with the power switch, white, UV, or off. They each use three LR1130 button style batteries which are included along with a battery compartment tool. This quality folding pocket magnifier has a 25 mm 40x lens. Includes a clear plastic protective case. #-5607 **\$14.95**



Plastic Storage / Carry Case is Included

45 X Mini Microscope

This small precision microscope is only 1.5 inches long but delivers clear 45 x magnification with UV light. Carry pouch is included. #-5606 **\$14.95**



ULTRAVIOLET LIGHTS

Key Chain Size LW UV Light



A single longwave UV LED provides 100,000 hours of long wave UV light for mineral ID, check currency and credit card validity, hand stamps or whatever you use UV light to accomplish. The wave length is 400 nm. #-5796 **\$3.95**



RAYTECH'S R5-FLS-2 Longwave / Shortwave UV Lamp offers both standard A/C operation & battery power for portable use and has a full 12 watts of power.

The Raytector R5 portable has an internal, rechargeable lead acid battery eliminating the need for replacements. One full charge of 24 hours gives 5 to 7 hours of battery operation. It is equipped with a built-in charger that plugs into wall outlets for intermittent or continuous recharging. Raytech's new dual tube models can operate with either one or both tubes simultaneously. Single tube operation extends battery life while double tube operation substantially increases the output intensity to a full 12 watts. Each lamp comes with Raytech's exclusive lifetime filters and A/C adapter.

Longwave and Shortwave with 12 watts of power!



#-7150 **\$295**



VERSALUME LW/SW UV Light



This versatile hand held ultra violet light provides either long wave or short wave UV light powered by 4 AA batteries, or 110 volt AC via the power adapter that comes with the unit. Includes the 65 page book "The Story of Fluorescence".

#-5782 **\$94.00**

ECONOMY ULTRAVIOLET LIGHT

This inexpensive portable longwave UV light runs on 4 AA batteries which makes it a great tool for field use. Dimensions are 6.25" x 2" x 1". Perfect for rockhounding and searching for scorpions at night in the desert.

#-5787 **\$10.95**



JOBE 19 LED UV Flashlight

This quality aluminum flashlight turns on the world of fluorescence with 19 super bright longwave UV LEDs in the 400 to 410 nm wave length. This is a lot of focused LED UV light in a very small light weight package measuring only 4 inches long and weighing only a few ounces. The unit is powered by only three AAA batteries which last a long time with the low power requirements of LEDs. The push button on-off switch is located at the end of the rugged black aluminum housing. A belt-carry case is included.



#-5799 **\$29.95**

HAND-HELD PORTABLE SHORTWAVE UV LIGHT by UVP

These hand-held portable UV lights are powered by 4 AA batteries.

#-5785 **\$59.95**



FLUORESCENT MINERALS COLLECTION

This expanded collection allows a study in detail of the response of these minerals to ultraviolet light. Some respond to shortwave, some to longwave and some to both. Kit is 7 inches x 11 inches with 15 samples of minerals. The mineral samples are about 1 1/2" x 1 1/2". By Hubbard Scientific.

#-3022 **\$40.00**



The Black Light Book for Antiques and Collectibles, 4th edition:

Published by the Antiques & Collectors Reproduction News, the illustrated monthly newsletter on antique fakes and reproductions, this is a must have book for collectors of glass, china, gemstones, cast iron, pottery, paper, metal, prints textiles, ivory and more. Includes a black light buyers guide with test reports. Includes a very good section on ultraviolet light basics. Paperback, 112 pages and 103 photos and illustrations.

#-4301 **\$14.95**



Fluorescence Experiment Kit

Learn about the amazing phenomenon of fluorescent minerals. When certain ordinary rocks are exposed to ultraviolet light, they actually emit visible light in brilliant colors! This kit contains a longwave ultraviolet light, a study guide, and 4 fluorescent mineral samples. These are all packed in an 8" x 12" x 2" wood case with two drawers.

#-2506 **\$39.95**



Collecting Fluorescent Minerals

Revised 2nd Edition: Seeing fluorescent minerals up close for the first time is an exciting experience. The colors are so pure and the glow is so seemingly unnatural. Hundreds of glowing minerals are shown, including Aragonite, Celestine, Feldspar, Microcline, Picroparmacolite, Quartz, Spinel, Smithsonite, plus many, more. Over 800 beautiful color photographs illustrate how fluorescent minerals look under the UV light, and in daylight, making this an invaluable field guide. Included are values, a comprehensive resources section, plus helpful advise on caring for, collecting, and displaying minerals. Stuart Schneider, 208 pages, soft cover, 8 1/2 x 11 inches. #-4324 **\$29.95**



The World Of Fluorescent Minerals

The rich and diverse world of fluorescent minerals is explored in this sweeping survey. Breathtakingly pure colors, with their ethereal glow, immediately capture your attention. To help the collector, over 825 photos display the minerals both as they might be found in daylight and under the effects of ultraviolet light. Written for the collector and the merely curious, this pictorial reference will enrich your collecting experience with its informative text. It is an essential source for enjoying and identifying fluorescent minerals. Stuart Schneider, 8 1/2 x 11 inches, 192 pages with a soft cover. #-4311 **\$29.95**

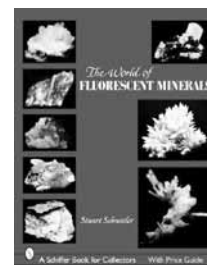

GOLD TESTING SUPPLIES

HOW DO THESE QUALITY GOLD TESTING ACIDS AND ACCESSORIES WORK?

The basic gold testing procedure is to make a small scratch test of the sample metal you are testing on the test stone. Drop a few drops of the test acid on the sample and observe it. If the quality of the gold is equal to or greater than the karat quality rated on the test acid the acid will not effect the sample. If the tested metal is not gold or is of a lower purity than the quality rated on the test acid the acid will destroy the sample. An optional method is to make two scratches on the stone, one with the sample metal being tested and another with a test needle of known purity gold. When you apply the acid you observe both scratches to see how they compare.

Precious Metal Testing Acids

Gold testing acids in handy 1/2 ounce plastic squeeze bottles. No mixing or pouring. Use in conjunction with a gold test stone.

#-6752 10 karat test **\$4.95**
 #-6753 14 karat test **\$4.95**
 #-6754 18 karat test **\$4.95**
 #-6755 22 karat test **\$5.95**

SILVER TESTING SOLUTION

Same as gold testing solutions except designed to test for silver.

#-6756 **\$4.95**

PLATINUM TESTING SOLUTION

Same as gold testing solutions except designed to test for Platinum.

#-6757 **\$4.95**

COMPLETE GOLD TEST KIT



Includes the 10k, 14k, and 18k testing acids along with the 2" x 1 1/2" test stone.

#-6758 **\$21.95**

GOLD TEST STONE

2 inch by 1 1/2 inch test stone to be used in conjunction with test acids to evaluate the karat quality of gold.

#-6751 **\$7.95**



5 PRONG GOLD TEST NEEDLES

To be used in conjunction with our gold testing acids and test stone to evaluate the karat content of gold. Set of 5 needles includes 8, 10, 12, 14 and 18 karat gold. #-6759 **\$69.95**



DISPLAYING YOUR STUFF

Gold Pokes: These quality leather gold pokes have a draw string to secure your finds. These supple leather pouches will hold your nuggets or gold vials. We have two sizes of doe skin and one of cowhide.

(A) Cow hide leather pouch is 4 inches tall and 2 inches wide. Will hold a 4 ounce gold vial.

#-5097 **\$4.00**

(C) Doe skin pouch is 4 inches tall and 2 inches wide. Will hold a 4 ounce gold vial.

#-5099 **\$4.00**

(B) Doe skin pouch is 3 inches tall and 2 inches wide. Will hold a 2 ounce gold vial. #-5098 **\$4.00**

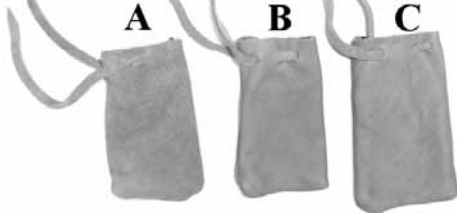

GEM JARS

These clear plastic jars with either black or white foam fillers come in three sizes. They are perfect for displaying your gold, gemstones, coins, beads or whatever.



14 x 8 DISPLAY TRAY WITH GEM JARS

Includes display jars in a plastic foam lined stackable tray. The tray is 14 inches x 8 inches and the jars are available in three sizes. Choose either white or black



foam in the tray and in the jars.

50 of the 1 1/4 inch display jars in the tray.

#-5664 specify white or black foam **\$19.95**

36 of the 1 1/2 inch display jars in the tray.

#-5669 specify white or black foam **\$19.95**

24 of the 1 3/4 inch display jars in the tray.

#-5674 specify white or black foam **\$19.95**

HALF SIZE DISPLAY TRAY WITH GEM JARS

Includes display jars in a plastic foam lined stackable tray. The half tray is 7 inches x 8 inches and the jars are available in three sizes. Choose either white or black foam in the tray and in the jars.

25 of the 1 1/4 inch display jars in the tray.

#-4951 specify white or black foam **\$12.95**

16 of the 1 1/2 inch display jars in the tray.

#-4953 specify white or black foam **\$12.95**

12 of the 1 3/4 inch display jars in the tray.

#-4955 specify white or black foam **\$12.95**



Display jars are not included.

SOLID OAK GLASS TOP DISPLAY CASE

This beauty is made in the USA and is a quality display case. Dimensions are 15 3/4 inches wide, 9 1/4 inches deep and 1 7/8 inches tall. The light oak finish is well done and the hardware is brass plated. Holds any of our 14 x 8 gem jar sets. Displayed here with a 50 gem jar insert which is not included.

#-6384 **\$49.95**



Display jars are not included.

\$16.95

GLASS TOP DISPLAY CASE

This clear glass top display box is hinged and closes with a secure latch. The case is 14 inches x 8 inches and holds any of our 14 x 8 display jar sets. The case is black and does not include display jars. #-5696

Aluminum Gem Jars in boxed sets.

These sets all contain 1 1/4 inch aluminum gem jars in boxed sets. The gem jars are made of aluminum with clear plastic inserts in the lid and a black foam insert. The boxes that hold the jars are either aluminum or wood.

This aluminum display box is 5 x 4 x 3/4 inches and comes complete with 12 aluminum gem jars with black foam inserts.

#5625 **\$7.95**



This aluminum display box is 7 x 5 x 3/4 inches and comes complete with 20 aluminum gem jars with black foam inserts. #5626



\$12.95

Wood Display Box with 40 gem jars.



This wood display box is 11 x 7 x 1 1/2 inches with a sliding acrylic lid. It comes complete with forty 1 1/4 inch aluminum gem jars with black foam inserts.

#-5627 **\$19.95**

This foam ring pad has 72 slots cut to display rings and it fits in any 8 x 14 inch box or tray. Colors available include black, red, burgundy and royal blue.

Foam Ring Pad



#-5639 **\$3.49**

Rings are not included.

DISPLAYING YOUR STUFF

RIKER TYPE DISPLAY BOXES

A beautiful way to display larger finds as illustrated by the Union Belt Buckle I found detecting in Virginia. Great for larger gold specimens, fossils, stones or whatever. This two piece display case has a glass window in the lid and is securely held closed by 2 large pins that insert through the sides. Comes with white foam. You can change the background to any color by covering the white foam with felt. Display boxes are black and are 3/4 of an inch deep.

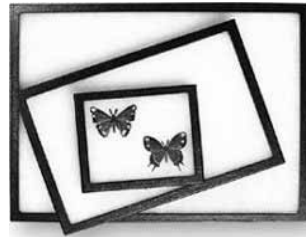

Example of a Riker Box Display with a Civil War Buckle, found in Virginia with a metal detector.

- #-6214 3" x 4" Box **\$2.95**
- #-6392 4" x 5" Box **\$3.95**
- #-6215 5" x 6" Box **\$4.95**
- #-6393 6" x 8" Box **\$4.95**
- #-6389 8" x 12" Box **\$5.95**
- #-6390 12" x 16" Box **\$8.95**

1 Inch Square Magnifying Display Boxes

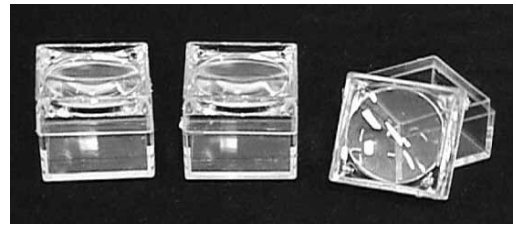

4X MAGNIFYING DISPLAY BOX

These crystal clear magnifying display boxes are 1" x 1" x 7/8" and are perfect for displaying your gold or mineral specimen finds. #-5080 **\$1.19 each**

25 one inch Mag Boxes with Stack Tray

This black plastic stack tray comes complete with 25 of the 4x display boxes. #-5644 **\$28.95**



50 one inch Mag Boxes with Stack Tray

This black plastic stack tray comes complete with 50 of the 4x display boxes. #-5643 **\$48.95**



How The West Was Won Wood Display Box

This neat little wood display box has twenty 1 1/4 inch gem jars to display your gold, and is imprinted with the "How The West Was Won" logo on top of the box. The box is 8 1/2 x 6 1/2 inches and 1 3/4 inches deep.



Detail of Imprint



#-6388

\$17.95

Wood Fossil and Mineral Collection Boxes

These wood collection boxes have brass plated latches and are divided into nine 2 inch square compartments to safely house and display your mineral or fossil samples. The interior compartments are divided by thin strips of plywood and with a fluffy cotton material on the bottom.



"Mineral & Fossil Collection Box"
9" x 7" x 2 1/4"
#-2501 **\$9.95**

"Collection Box"
9" x 7" x 2 3/4"
#-2505 **\$9.95**

Inside View



STAINLESS STEEL TWEEZERS

Fine point stainless steel tweezers for picking up small pieces of gold from your pan. Antimagnetic, 4 1/2 to 5 inches long. #5004 **\$3.95**



ANGLED TIP STAINLESS STEEL TWEEZERS



Same as above except with an angled tip. #6826 **\$3.95**



PLASTIC SUCTION TWEEZERS

Polypropylene tweezers make it easy to pick up even the finest gold out of your pan. #5003 **\$.25**

SMALL PLASTIC FUNNELS

These small unbreakable funnels are perfect for filling sample vials with gold.

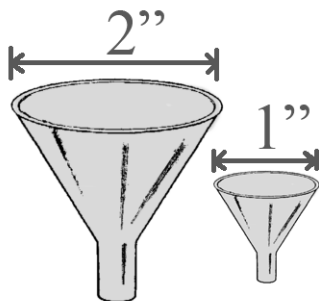

#5022 #5021

#5021 1 inch wide **\$.69**
#5022 2 inches wide **\$.99**

GLASS DISPLAY VIALS

Sold in 10 packs.

PLASTIC STOPPER

SCREW CAP

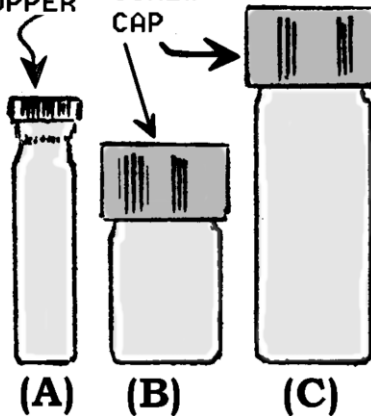

| TYPE | CATALOG | SIZE (gold) | PRICE |
|------|-----------------------------------|-------------|---------------|
| A | #-5014-10 <i>(actual size)</i> | 2 dwt | \$3.40 |
| B | #-5015-10 <i>(actual size)</i> | 1/2 oz | \$3.80 |
| C | #-5016-10 <i>(actual size)</i> | 1 oz | \$4.50 |
| C | #-5017-10 | 2 oz | \$4.70 |
| C | #-5018-10 | 3 oz | \$4.90 |
| C | #-5019-10 | 4 oz | \$6.00 |

The size of these vials are stated in the amount of placer gold they will hold.

CLEAR PLASTIC VIALS: Threaded top clear Polypropylene Vials with integral cap side seal. These rugged vial are perfect for field use as they will not break if accidentally dropped. Screw caps with the unique side seal are included.

#-6580

Actual size as illustrated.
Sold in 10 packs.

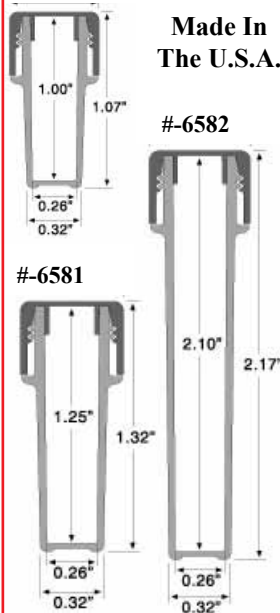

Made In The U.S.A.

#-6582

#-6581

| CATALOG # | Liquid Volume | SIZE (gold) | PRICE |
|------------------------------|---------------|-------------|---------------|
| #-6580-10 | .86 ml | 1/4 oz | \$4.20 |
| #-6581-10 | 1.09 ml | 1/3 oz | \$4.40 |
| #-6582-10 | 1.83 ml | 1/2 oz | \$5.00 |
| #-6583-10 | 4.43 ml | 1oz | \$5.00 |
| #-6584-10 | 7.69 ml | 2oz | \$6.00 |
| #-5034-10 not illustrated | 19.52 ml | 5 oz | \$7.00 |

#-6583

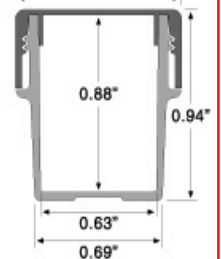

#-6584

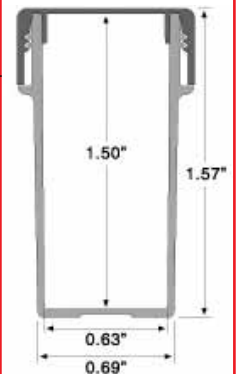

Snuffer Bottle Holster

This leather holster will hold either of our snuffer bottles securely to your belt so you can quickly access it, but not lose it. A snap release belt loop is included.

#5049

\$5.99

Snuffer bottle is not included.



GARRETT PREMIUM GOLD GUZZLER BOTTLE

The "GOLD GUZZLER BOTTLE" acts as a hand-held vacuum sucking the gold out of your pan when the plastic bottle is squeezed and released. Your gold is safely stored until you want to remove it from the bottle. The Garrett GOLD GUZZLER Bottle is manufactured by Garrett Electronics.

#G-1650300 **\$3.95**



SNUFFER BOTTLE

The "SNUFFER BOTTLE" acts as a hand-held vacuum sucking the gold out of your pan when the plastic bottle is squeezed and released.

Your gold is safely stored until you want to remove it from the bottle.

About 6 inches tall.

#5001 **\$2.98**

Mini Snuffer

Same as above only smaller.

The Mini Snuffer is about 2/3 the size of the original snuffer.

#5028 **\$2.98**

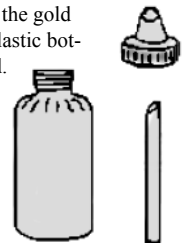

HATS

Weather Beater Cap

This is a great cap with protective apron to cover your ears and neck. These are cotton caps in a digital desert camouflage. An adjustable elastic cord makes a comfortable one size fits all. Perfect for metal detecting, treasure hunting, rock collecting, sailing or any outdoor activity.



#-5827 **\$10.95**

One size fits all

One size fits all.

SUN RUNNER HAT

This all purpose quality hat is perfect for rock collecting, prospecting, and metal detecting. It has an extra large bill and a removable apron to protect the back of your neck and ears from the sun. One size fit all and the color is Khaki. #5823 **\$12.95**



Khaki Color

Removable Apron



Classic Pith Style Helmet

One size fits all



The ideal hat to protect you from sunlight's harmful rays, yet keep you cool and comfortable. Adjustable plastic head band with terry-cloth sweatband fits all head sizes (6 1/2 - 7 3/4). The optional chin strap can be pulled down to secure hat in windy conditions. Very lightweight, only 6 ounces. You will hardly know it's on your head. The tan color and lightweight combine for easy trekking in hot weather.

#-5821 **\$14.95**

#-6070 Solid Crown

Safari Hats

A hat that not only protects you from the elements-wind, sun and rain but just looks good. Adjustable leather tie-down cord ensures that your hat stays put, even in gusty winds. Constructed of water repellent and mildew resistant fabric, this hat will stand up to the toughest weather conditions. Available in Khaki and Olive colors with a solid fabric crown, or a mesh crown for cooler summer use. These hats have a specially designed internal sweat band that is expandable and therefore requires only 2 sizes. Small-Medium or Large-X Large.



#-6071 Mesh Crown



#-6070 (Small-Medium) Solid Crown **\$18.95**
 #-6070 (Large-X Large) Solid Crown **\$18.95**
 #-6071 (Small-Medium) Mesh Crown **\$18.95**
 #-6071 (Large-X Large) Mesh Crown **\$18.95**
Specify Color Khaki or Olive



One size fits all

The Topper

This little number is like a traveling tree, providing protection from the sun and whatever the weather throws at you. It protects the front, back, and sides of your head. The long back-flap also protects your neck. The standard color is Khaki but others are available. One size fits all.

#-5828 **\$9.95**



Fisher Flying F baseball cap.

#F-8703301000 **\$14.95**



Garrett Metal Detectors baseball cap.

#G-1663300 **\$9.95**



TESORO Metal Detectors baseball cap.

#T-TA040 **\$14.95**



Garrett AT PRO baseball cap.

#G-1663400 **\$9.95**

Garrett ACE black baseball cap. #G-1663100 **\$9.95**



HOW TO FIND GOLD

Also check these other locations for related methods of finding gold.

Finding gold with a metal detector pages 65 and 66.

How to stake a mining claim page 33.
Books on Drywashing see page 36.

HOW TO FIND GOLD

The latest methods and equipment geology of placer deposits, staking a claim and much more. Illustrated. Klein & Keene, 120 pages.
#-5281 \$9.95



Modern Prospecting: How to Find, Claim And Sell Mineral Deposits

A gold pan, a couple of screens, a small shovel, rock hammer, hand lens, and sample bags are the essential tools for prospecting. However to have a better chance of discovering a deposit, a prospector must also recognize the signpost of a favorable area, do the land status research, and follow through with a valid claim staking, soil and rock sampling, and assaying. Roger McPherson, 6x9 soft cover with 303 pages.
#-5227 \$14.95



GOLD: ABC's of Panning

Reprint of an old classic, this book illustrates how to find placer gold, how to use a gold pan, and what equipment is needed. Legaye, 90 pages.
#-5292 \$9.95



Gold Mining in the 21ST Century

This is the 280 page "how-to-do-it" book for gold prospectors: what gold is; where it comes from; where to find it; panning gold; sluicing; dredging; drywashing; lode mining; electronic prospecting; cleaning and selling gold, and much more. Dave McCracken, newly revised.
#-5380 \$19.95



GOLD! GOLD!

Beginning guide and recreational handbook. Includes historical and geographical background as well as traditional and modern recovery methods. Describes where you can still find gold in the U.S. today. Pertralia, 144 pages. #5295 \$12.95



GOLD FEVER

Favorite among beginners. Full page illustrations on the mechanics of panning and sluicing. Maps of Western states gold locations. Numerous illustrations. De Lorenzo, 80 pages. #5294 \$6.95

GOLD PROSPECTOR'S HANDBOOK

Geological background dynamics of steam flow, how to pan for gold, and what tools to use. Non technical but advanced book for the prospector. Excellent glossary. Black, 176 pages. #5299 \$10.95



Placer Gold Mining

A book of methods and materials for recreational placer gold miners. First printed in 1980 it covers all the basics on the tools and techniques used in prospecting for placer gold. Well illustrated with a nice glossary of related terms. Allin R. Copp, 81 pages, 5 1/2 x 8 1/2 inches with a soft cover.
#-5323 \$8.95



Underwater Sniping For Gold

This is a great book by Sam Radding and Jim Garlock. True to its title it is the first book that covers the art of sniping for gold. These techniques use inexpensive tools, many of which he includes plans to build them yourself, you can go after the big gold. This book covers much more than sniping. It has a large section of maps and descriptions of gold areas in California and vicinity. 144 pages, soft cover, 6 x 8 inches. #5239 \$11.95

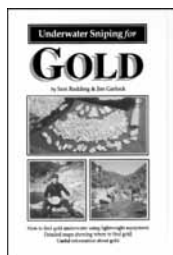

The Modern Goldseekers Manual

This book will introduce you to the equipment and the techniques used by recreational or small scale miner. Includes well illustrated equipment plans with detailed instructions in the use of all the common gold prospecting equipment. It includes a section on amalgamation and searching for diamonds. Tom Bryant, 5 1/2 x 8 1/2 soft cover with 243 pages. #5301 \$19.95

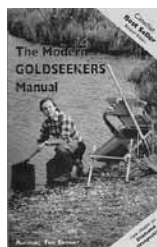

DIVING AND DIGGING FOR GOLD

Presents various methods of extracting gold including hunting underwater. Illustrated. HILL. 48 pages. #5266 \$6.95

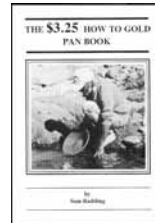

THE \$3.25 HOW TO GOLD PAN BOOK

Every thing you need to know to learn to pan for gold. By Sam Radding, 28 pages.
#5811 \$3.25

LOOKING FOR GOLD

Detailed instructions for mining both lode and placer gold. Covers equipment, laws, supplemental gear and staking a claim in the United States and Canada. By Bradford Angier with 220 pages, 6 x 9 inches soft cover.
#5262 \$19.95



GOLD PROSPECTORS DIGEST

An updated version of Jerry Keene's classic with chapters on all kinds of prospecting including electronic prospecting. 51 pages. #5286 \$7.95



GOLD PANNING IS EASY

Field guide for the beginner that shows exactly how to find and pan gold. Color and B/W photos. Legal., 134 pages.
#G-1505470 \$9.95

The Weekend Gold Miner:

One of the most popular gold titles. The author becomes your personal guide to finding gold and recovering it. A.H. Ryan, PH. D, 5 1/2 x 8 1/2 inches, soft cover, 80 pages.
#-5309 \$5.95



RECREATIONAL GOLD PROSPECTING FOR FUN & PROFIT

All the basics of recreational gold prospecting including how to use a gold pan, how to file a claim and how to sell your gold. Gail Butler, 206 pages. #6471 \$12.95



Drywashing For Gold

Updated edition with more on modern electronic prospecting and current equipment. Describes dry washing, a profitable means of extracting gold in regions where water sources are not available. Illustrated. James Klein 89 pages, 5 1/2 x 8 1/2 inches, soft cover.
#-5383 \$9.95



Mercury Free Gold Recovery from Black Sand Concentrates (DVD)

Learn how to recover all your gold from black sand without the use of mercury. Watch previously unrecoverable fine gold values separate from the concentrates with proven techniques developed by professional miner, Jeff Pickett. This DVD gives detailed step-by-step instructions, broken down into easy-to-follow fine gold recovery techniques.

#-6147 \$39.95

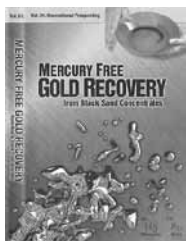

GOLD PANNING (DVD) with Don Robinson

DVD with detailed gold panning instructions. Learn to pan for gold in less than 30 minutes.

#-6249 \$15.00

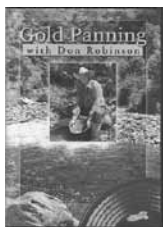

Gold Dredger's Handbook: How To Find A Lot Of Gold Using A Suction Dredge.

In easy to understand language, supported by clear photographs and graphic illustrations, this book covers all of the important information you need for successful gold dredging. Includes the legalities, and detailed information on where gold comes from and why it forms high-grade deposits. Dave McCracken, 5 1/2 x 8 1/2 inches, 364 pages with a soft cover. #-6261 \$12.95



Advanced Dredging Techniques Part 1

Everything you need to know for successful dredging. Dave McCracken, 176 pages.

#-6258 \$10.95

Advanced Dredging Techniques Part 2

Everything you need to know for successful dredging.

Dave McCracken, 224 pages. #-6259 \$10.95



Fists Full of Gold

Everything about finding, recovering and selling gold. Chapters on equipment, geology and techniques make this an all inclusive volume of knowledge on all aspects of gold prospecting. Chris Ralph, 8 1/2 x 11 inches, 361 pages with a soft cover. #-5289 \$29.95

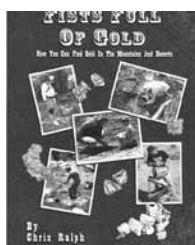

MODERN GOLD MINING TECHNIQUES (DVD)

Dave McCracken, combines years of experience with advanced video effects to DEMONSTRATE successful modern gold mining techniques. This video covers the basics of gold geology and shows you where to locate gold deposits, extensive computer graphics, a simulated river showing where gold travels and deposits, sampling techniques, and a comprehensive visual demonstration of gold panning, mossaing and sluicing techniques, sniping, the basics of gold dredging and lode mining, drywashing, hydraulic concentrating, electronic prospecting, gold clean-up steps, and much, much more. Virtually a video encyclopedia of basic modern gold mining techniques!

#-6145 \$49.95



SAM RADDING'S BOOKS OF PLANS:

This two volume set of plans are easy to understand custom designed plans for the construction of light-weight recreational gold mining equipment.

SAM RADDING'S VOLUME I

Volume I contains detailed plans for the following projects.

Port A Sluice
Rocker Box
Small Rocker
Wooden Concentrator
Rocker Concentrator
Aluminum Concentrator
Bellows Drywasher
Conveyor Belt
#-5204 \$14.95



SAM RADDING'S VOLUME II

Volume II contains detailed plans for the following projects.

Underwater View Scope
Sniping Tools
Snuffer Bottle
Crack Hook
Fanning Board
Suction Stick
Vibrobasic Drywasher
Mini-Magic Drywasher
Gold Classifying Screens
#-5490 \$14.95

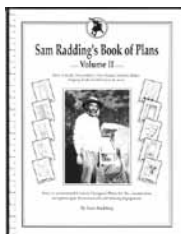

Successful Drywashing

Everything you need to know about drywashing. Well illustrated with lots of pictures of unusual drywashers. Includes a section on how to sample and estimate the gold value of placer gravel. Jim Straight, 34 pages. Soft cover, 5 1/2 x 8 1/2 inches. #-5282 \$9.95



WORKING THE DRYWASHER (DVD)

The best video ever produced for the prospector who owns a drywasher but is not experienced in using it, or the guy who is considering purchasing a drywasher. Hosted by Mojave John, this video is professionally done and covers all the basics of drywashing. In two parts you first go through the science of drywasher design, setup and options. Then it is off to the desert to use two different drywashers in the field. A small sniping-type drywasher, testing areas for gold and then a larger production drywasher. Running time 60 minutes, in color. #-6131 \$19.95

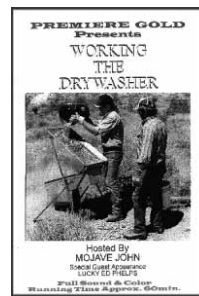

Successful Gold Dredging Made Easy (DVD)

Dave McCracken makes use of the powerful medium of video to reveal his techniques for locating and dredging up paystreaks. Noted author of numerous books and articles on the subject, Dave combines years of experience with advanced video effects and underwater videography to provide valuable information on all aspects of gold dredging, from locating gold bearing areas, and reading the river, to useful tips on final clean-up procedures. The most important thing to learn in gold dredging is how to find the paystreaks. This video SHOWS you how to do it! It follows Dave through his complete operation, from start-up, to sampling, to production to final clean-up. #-6267 \$49.95



ADVANCED DREDGING AND SAMPLING TECHNIQUES (DVD)

This video contains extensive above and below water coverage of Dave McCracken's 8-inch commercial dredging operation; above and below water winching techniques; commercial testing and paystreak evaluation procedures; how to safely take apart keep gravel deposits; production dredging techniques; demonstrations of centrifuge, shaker table, rod mill, screen plant, continuous feed amalgamator, hydromatic jig; and much, much more! A wealth of valuable information about commercial gold dredging and sampling techniques! Whether you are a novice exploring a new hobby, or an experienced gold miner looking for new ways to increase gold production, you will find Advanced Dredging and Sampling Techniques packed with DEMONSTRATED information that no book could ever present. #-6269 \$49.95

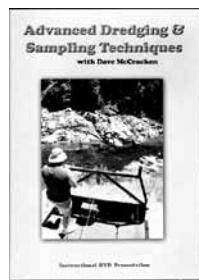

GOLD PAN FEATURES IN GENERAL

There are a wide variety of gold pans available in our catalog and they all have advantages and disadvantages that you should consider in choosing a gold pan.

PAN SIZE

The size of the gold pan is important and there are several dimensions that you should consider. In the above illustration the top diameter of the pan is referenced as (A). This gives you an idea of the overall size of the pan and they are available from 6 inches to 16 inches in width. A larger pan has the advantage of holding more material and therefore allowing more production. A large pan full of material is heavy and can be tiresome. A small pan is handy as a finishing pan to complete the final separation of gold from black sand concentrates. A smaller pan is also easier to use when you are not panning in a stream or lake where you have lots of water and room.

Dimension (B) represents the depth of the pan which is also a good indication of how much material it will handle without overloading it.

Dimension (C) represents the size of a straight drop between the sloped edge of the pan and the bottom. The size of this drop varies and some pans do not have this feature at all. This drop creates an extra riffle at the bottom of the pan. Some experienced panners use this riffle as the first and best chance to capture their gold. Dimension (D) represents the size of the bottom of the pan. A large bottom relative to the overall size of the pan is handy when you get to the point of separating the gold from the last black sand.

TYPE OF PAN MATERIAL

Gold pans can be made out of plastic, steel, or copper. The most common pans are made of plastic which is light, can be made with deep riffles and do not rust. Steel pans are heavier, usually have small riffles, if any, and are subject to rust. Many old timers prefer the smooth sides of the steel pan. Copper pans are made specially for using with mercury or for presentation pieces.

COLOR OF THE PAN

Plastic pans are available in several colors. The most common color is black which makes gold easily visible but tends to mask black sand. Blue and green pans are popular and make the gold and black sand easily visible.

PRETREATMENT OF NEW GOLD PANS

New plastic pans are coated with a mold release material in the manufacturing process that will cause the pan to work ineffectively at first because the mold release compounds are lubricants and will cause water to bead up. This will be eliminated after the pan is used for awhile. The process can be speeded up by thoroughly cleaning the pan with a good degreasing detergent. Sometimes steel wool helps. Be careful not to scratch the surface of the pan too much.

New steel pans usually are impregnated with oil from the spinning process used to manufacture them. This oil can easily be removed by heating a new steel pan on your stove top burner or with a propane torch until it is very hot. The heating will quickly burn away any oil residue but will create a little smoke. If you want a nice blued finish on the pan you can pick it up with a pair of pliers, while it is still hot, and drop it into cold water. Be careful you don't burn yourself. If you do not want to use the heat process you can follow the same instructions provided above for plastic pans.

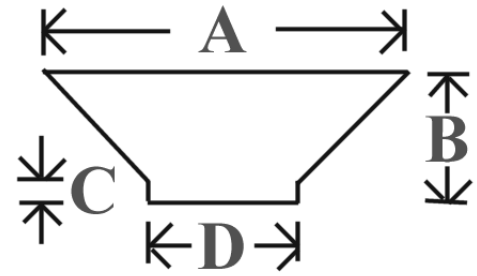

Steel Gold Pans with Riffles and Big Bottoms

These steel pans have riffles and are designed with wider bottoms.



- #-6849 10 Inch Steel Pan w/ riffles **\$8.95**
- #-6850 12 Inch Steel Pan w/ riffles **\$10.95**
- #-6851 14 Inch Steel Pan w/ riffles **\$11.95**
- #-6852 16 Inch Steel Pan w/ riffles **\$12.95**

| Size | A | B | C | D |
|------|-----|--------|----|--------|
| 10" | 10" | 2" | 0" | 5" |
| 12" | 12" | 2" | 0" | 7" |
| 14" | 14" | 2 1/2" | 0" | 8 1/2" |
| 16" | 16" | 2 3/4" | 0" | 10" |



STEEL GOLD PAN

These heavy duty steel gold pans have no riffles. They are just like the ones the old timers used in the gold rush.

- #-5157 6 inch pan **\$5.95**
- #-5006 10 inch pan **\$7.95**
- #-5156 12 inch pan **\$8.95**
- #-5155 14 inch pan **\$9.95**
- #-5795 16 inch Pan **\$11.95**

| Steel Pan | A | B | C | D |
|-----------|-----|------|------|------|
| 6" | 6" | 1" | .13" | 2.5" |
| 10" | 10" | 1.5" | .13" | 4.5" |
| 12" | 12" | 2" | .13" | 5.5" |
| 14" | 14" | 2.5" | .13" | 6" |
| 16" | 16" | 3" | .13" | 8.5" |

Roaring Camp 12 inch Gold Saver Pan



The famous gold trap in the bottom of the pan is a unique and patented feature in the Roaring Camp Gold Saver Pan. Made of durable plastic for years of rugged service and available in green and burgandy.

#-5044 **\$10.95**

| A | B | C | D |
|-----|--------|----|----|
| 12" | 2 1/2" | 0" | 8" |

The gold trap is a depressed area in the bottom of the pan designed to quickly catch gold. It is 3" wide, extends 1" toward the back of the pan and is 1/4" deep.



SOLID COPPER GOLD PAN FOR AWARDS

This eleven inch solid copper gold pan has an extra wide bottom and is perfect for plating and /or engraving to create distinctive awards. Can also be used for normal gold panning and for amalgamation.

#-5783 **\$29.95**

| Size | A | B | C | D |
|------|-----|----|----|----|
| 11" | 11" | 2" | 0" | 7" |



Made
in the
USA



The JOBE ARCHER 10 inch and 14 inch plastic gold pans are the "cats' meow" in gold pans for beginners or the most experienced panner. The new terra cotta and steel gray colors are both perfect for highlighting gold and black sand. The pan pictured above is the 10 inch pan, the 14 inch pan has an additional riffle.

#-5048 10 inch pan \$6.95

#-5047 14 inch pan \$9.95

| | A | B | C | D |
|---------|-------|--------|------|--------|
| 10" pan | 10.5" | 2" | 1/8" | 5 3/8" |
| 14" pan | 14" | 3 1/4" | 1/4" | 8" |

Hex Pan

One of the most unusual but completely functional pan designs ever. The hexagonal shape allows for two sets of deep primary riffles to form an amazingly efficient gold trapping trough. There are also two sets of sixteen secondary riffles for basic clean up, and two sides with a textured surface for final clean up. When you experience the gold catching effect of panning in a trough you will wonder why it took so long for someone to figure it out. Every prospector should own one of these pans as it is perfect for a pro or a beginner. The Hex Pan is 15 inches across, three inches deep, and is made of very durable polypropylene plastic. The Hex Pan is available in four colors, black, blue, green, and purple. #-5086 \$15.95

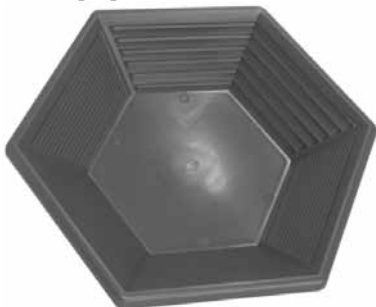

| A | B | C | D |
|-----|----|----|----|
| 15" | 3" | 0" | 8" |

The Le Trap SQUARE PAN

The secret is in the riffles that offer 85% more gold trapping area than conventional gold pans. The riffles are set at exactly the correct angle to hold gold and wash away sand and gravel. Made of green plastic it is 18" long, 12" wide, 4" deep, and weighs 16 ounces. Made in Canada.

#-5084

\$16.95

**Le[®]Trap
WONDER PAN**



TRINITY BOWL Gold Pan

The new Trinity Bowl gold pan is the most revolutionary change in gold pan design since the Le Trap square pan. It is a very complex double sluiced design with a recessed riffle trap and a raised bottom. These features combined make it almost impossible to lose gold. The Trinity Bowl is 14 inches in diameter

and made of durable plastic.

Works very well with fine gold in black sand.

#-5079

\$17.95 Available in Blue or Green

| A | B | C | D |
|-----|------|----|----|
| 14" | 3.5" | 0" | 8" |



1849 Gold Pan

11 inch plastic gold pan with deep riffles, a big bottom and a deep drop from the sloped sides to the bottom. Available in black, blue, and green. #-5066 \$6.95



| A | B | C | D |
|-----|------|------|----|
| 11" | 2.5" | .25" | 6" |

JOBE BASIC GOLD PANS

Black plastic with smaller riffles, these are your basic 10 inch and 14 inch gold pans.

#-5050 10" Pan \$3.49

#-5051 14" Pan \$5.95



| Plastic | A | B | C | D |
|---------|-----|------|----|----|
| 10" pan | 10" | 2" | 0" | 5" |
| 14" pan | 14" | 2.5" | 0" | 6" |

Gold Grabber Gold Pans

These Gold Grabber pans are a unique blend of rectangular and round gold pans. The normal discharge end is round like a conventional gold pan while the back end is rectangular to make it easier to work the material. They come in two sizes. The Gold Grabber Mini is 14 inches long and 10 inches wide. The standard Gold Grabber pan is 17 inches long and 14 inches wide.



Gold Grabber Gold Pan

The standard Gold Grabber is available in a dark forest green color. 17 inches long, 14 inches wide and 4 inches deep. #-5781 \$15.95



Mini Gold Grabber Gold Pan

Available in a light green and a light blue color. 14 inches long, 10 inches wide and 3 inches deep.

#-5780 Blue \$12.95

#-5780 Green \$12.95



GARRETT PANNING KIT

This kit contains the patented Gravity Trap 14" and 10" gold pans, a general purpose classifier with a 1/2" mesh, a Gold Guzzler Bottle, and a book on panning techniques. It also includes a pair of fine tipped tweezers with an attached magnifier and 2 plastic vials. All are nicely gift boxed.

#G-1651300 **\$29.95**



GARRETT DELUXE GOLD PANNING KIT

This kit contains the patented 15 inch SuperSluice Gold Pan, the Gravity Trap 14" and 10 1/2" pans, a 1/2" mesh plastic classifier, the Gold Guzzler Bottle, and a book on panning techniques. The Garrett Gold Panning Is Easy book and video are included along with a pair of fine tipped tweezers with an attached magnifier and 2 plastic vials. All are nicely gift

boxed. #G-1651400 **\$49.95**



NEW GARRETT SUPER SLUICE GOLD PAN

This 15 inch plastic pan has a set of huge riffles and a big 9 inch wide bottom. Works great as a dry panner also.

#G-1650400 **\$9.95**

| Garrett | A | B | C | D |
|---------|-----|-------|----|----|
| 15" pan | 15" | 3.25" | 0" | 9" |



Gravity Trap Pans

Garrett's green plastic gold pans are built for long service and have been a standard in the industry for years.

14 Inch PAN

#G-1650000 **\$8.95**



10 1/2 inch Pan
#G-1650100 **\$7.95**

| Garrett | A | B | C | D |
|---------|-------|----|-----|------|
| 10.5" | 10.5" | 3" | .2" | 3.5" |
| 14" | 14" | 3" | .2" | 6" |



New Pioneer Blue Gold Pan

Ideal gold pans for beginners or pros. Includes deep riffles for quick panning and small riffles for fine panning. These are the same pans as the KEENE and Estwing blue plastic gold pans.

- #-5023 10" pan **\$6.95**
- #-5024 12" pan **\$7.95**
- #-5025 14" Pan **\$8.95**
- #-5026 16" Pan **\$10.95**

| Pioneer | A | B | C | D |
|---------|-----|-------|----|------|
| 10" pan | 10" | 2.25" | 0" | 5.5" |
| 12" pan | 12" | 2.75" | 0" | 6.5" |
| 14" pan | 14" | 3" | 0" | 8" |
| 16" pan | 16" | 4" | 0" | 9" |



PROLINE GOLD PANS

Proline 14 inch and 17 inch plastic pans have deep riffles, a wide bottom and are very popular. They are available in blue, green, and black.

- #-5778 14" (specify color) **\$11.95**
- #-5789 17" (specify color) **\$17.95**

| Proline | A | B | C | D |
|---------|-----|-------|----|----|
| 14" pan | 14" | 3.25" | 0" | 8" |
| 17" pan | 17" | 4.25" | 0" | 9" |

FALCON Blue Finishing Pan

This is your basic blue plastic 11 inch finishing pan. No riffles and no textured surfaces makes it perfect for a final clean up gold pan.

#-5779 **\$6.95**



| FALCON | A | B | C | D |
|---------|-----|-------|----|----|
| 11" pan | 11" | 1.75" | 0" | 7" |

GOLD BUDDY



Made in the USA

GOLD BUDDY "Strike it Rich" Gold Panning Kit

This is a great gold panning kit for anyone from the beginner to the seasoned veteran. This kit contains the Archer 10 and 14 inch gold pans along with the general classifier that is designed to fit in the top of a 5 gallon bucket. A very well written book covering gold panning and basic prospecting along with a gold panning instructional DVD. You also get a snuffer bottle and two suction tweezers to remove the gold from your pan and a shatterproof clear plastic vial to display your gold.

#-6160 **\$49.95**



Made in the USA

GOLD PANNING BEGINNERS KIT

This kit includes the Archer 10 inch plastic gold pan, a suction tweezer to pick the gold out of the pan, a handy vial to display the gold, a folding 10x pocket magnifier and a very good how-to-pan book. Everything you need to be on your way to being a proficient gold hound.

#-6161 **\$14.95**

FISHER GOLD Panning Kits



Fisher Hardrock Pro Gold Prospecting Kit:

- 10 1/2" Gold Pan (Made in the USA)
- 14" Gold Pan (Made in the USA)
- Classifier (Made in the USA)
- Two 1oz Shatterproof Vials
- Snuffer Bottle
- Top Hat Black Sand Magnet
- Treasure Scoop
- Drawstring Bag
- Precision Tweezers
- Magnifier
- Crevice Tool
- Rock Pick
- Gold Prospecting Panning Guide

#-F-GoldKit3 **\$149.99**

Fisher Deluxe Gold Prospecting Kit:

- 10 1/2" Gold Pan (Made in the USA)
- 14" Gold Pan (Made in the USA)
- Classifier (Made in the USA)
- Two 1oz Shatterproof Vials
- Snuffer Bottle
- Top Hat Black Sand Magnet
- Treasure Scoop
- Drawstring Bag
- Gold Prospecting Panning Guide

#-f-GoldKit2 **\$79.99**

Fisher Gold Panning Kit

- 10 1/2" Gold Pan (Made in the USA)
- 14" Gold Pan (Made in the USA)
- Two 1oz Shatterproof Vials
- Snuffer Bottle
- Gold Prospecting Panning Guide

#-F-GoldKit1 **\$39.99**

GOLD PANNING (DVD) with Don Robinson

DVD with detailed gold panning instructions. Learn to pan for gold in less than 30 minutes.

#-6249 **\$15.00**



JOBE Stainless Steel Classifiers



| | | |
|--------|--------|---------|
| 1/2" | #-6402 | \$23.95 |
| 1/4" | #-6404 | \$23.95 |
| 1/8" | #-6406 | \$23.95 |
| 1/12" | #-6408 | \$23.95 |
| 1/20" | #-6410 | \$23.95 |
| 1/30" | #-6412 | \$23.95 |
| 1/50" | #-6414 | \$23.95 |
| 1/70" | #-6415 | \$23.95 |
| 1/100" | #-6416 | \$23.95 |

JOBE Stainless Steel Classifiers

These quality stainless steel classifiers have rugged plastic bodies with stainless steel screens. They are 12 inches wide at the top and are tapered to fit in the top of a 5 gallon bucket. The overall height is 3 1/2 inches and designed to allow for 4 of the classifiers to be nested with an overall height of only 8 1/4 inches. They are easy to use and a must for proper fine gold recovery.

Made In The Good OLD USA



**JOBE classifiers
are like birds in
that they
"nest nicely."**

4 nested classifiers are
only 8 1/4 inches tall



Miscellaneous Classifiers

JOBE General Classifier

Designed to nest with the JOBE stainless steel classifiers, it has the same plastic body with 5/16 inch square holes. It will fit in the top of a 5 gallon bucket and quickly sort out material that is too large to be processed by your recovery equipment. 100% plastic with UV protection for long life.

#-6417 **\$14.95**



Keene General Classifier

Designed to work with the Keene stainless steel classifiers, it has the same deep body with 5/16 inch square holes. 100% plastic with UV protection for long life. #K-SGP3 **\$14.95**



24 Inch Panning Gloves

24 inch long black rubber panning gloves with textured fingers. Keep your hands dry when gold panning or working with a sluice etc.

#-6514 **\$14.95**



Cotton Insulation Gloves



These cotton gloves are worn under the rubber panning gloves to insulate your hands from cold water.

#-6513 **\$.99**

Stainless Steel Bowl Classifier

This bowl shaped classifier is 7 1/2 inches in diameter and 3 inches tall. The stainless steel screen is about a 20 mesh, similar to a screen door. This is a great classifier for gold panning or to use with your rock tumbler. #-2005 **\$7.95**



GARRETT 14 inch CLASSIFIER

The Garrett green plastic heavy duty classifier has 1/2" openings and fits into the top of a 5gallon bucket.

#G-1650200 **\$7.95**



Mineral Identification

Deluxe Hardness Picks



Wood Case with the lid attached.

This set includes 8 points of durable metals of Moh's hardness 2 through 9, a grindstone to keep the points sharp, a magnet to detect magnetic rock, a compact wood case and complete instructions. Determining the hardness of minerals on the Moh's scale is essential to mineral identification. A streak plate is included for streak color test. #-3027 **\$79.95**

Hardness Sample Collection with Test Kit



The determination of the hardness of a mineral can be an important step in identification. This kit includes a sample of a mineral with each of the hardness characteristics from 1-9 on the Moh's scale. It also includes the basic tools to identify hardness, an iron nail, a ceramic streak plate and a piece of glass. Instruction are included.

#-3021 **\$19.95**

10 White Streak Test Plates

These 1" x 2" unglazed porcelain tiles are ideal for streak testing of mineral samples. The streak test is essential in mineral identification because it retains the color of the mineral. This is a package of 10 plates. #-3020 **\$6.95**

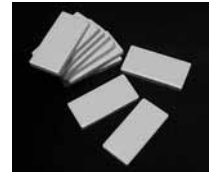

Rock & Mineral ID Books

Handbook of Rocks

Minerals & Gemstones:

This essential guide discusses the science of minerals origins, properties, structure, and classification. Written for the layman and scientist complete with 600 detailed color photos. Walter Schumann, 380 pages, 5 x 7 1/2 inches with a soft cover. #-4318 **\$22.00**

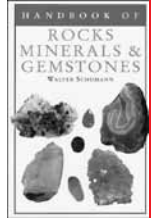

Rocks, Crystals, Minerals: Complete Identifier

The new compact study guide. Concise descriptions of each rock, crystal, and mineral, with symbols. Provides at-a-glance information on distinctive features, composition, and physical properties. Striking color photographs of specimens from around the world. More than 200 rocks, minerals, and crystals. Rosie Hankin, 6 x 8 inches, 224 pages, with a hard cover. #-4307 **\$9.99**

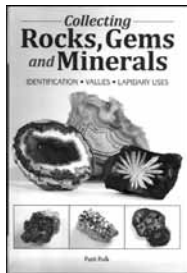

Collecting Rocks, Gems and Minerals

Designed with the beginner in mind but filled with valuable technical information for advanced collectors. Includes organics like amber, bone, coral, pearl, and shell. Contains more than 650 full-color photos. Provides values and tips for locating, buying and collecting. Patti Polk, 6 x 9 inches, 271 pages with a soft cover. #-4306 **\$17.99**

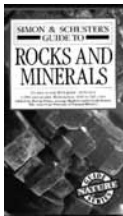
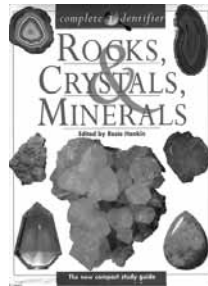

S&S GUIDE TO ROCKS AND MINERALS

A practical field guide to identify rocks and minerals. Over 1000 photographs and illustrations including 600 in spectacular full color. Harlow & Peters, 608 pages. #-5261 **\$19.00**

DK Handbooks Rocks & Minerals

A very good recognition guide has 256 pages packed with color photos and illustrations. Includes crystal forms, mineral group and hardness. #-4304 **\$20.00**

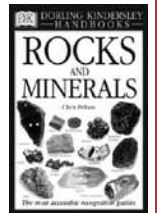

Peterson Field Guide to Rocks & Minerals

Detailed descriptions of 270 minerals: geographic distribution, physical properties, chemical composition, crystal-line structure, and more. Color photos. Pough, 320 pages. #6280 **\$20.00**

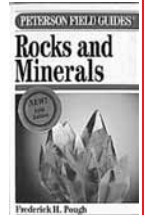

Audubon Field Guide to Rocks & Minerals: North America

National Audubon Society. 794 full-color images are cross referenced to detailed descriptions of field patterns and rock locations. Excellent and comprehensive index. Charles W. Chesterman, 850 pages, 4 x 8 inches with a soft cover. #5223 **\$19.95**

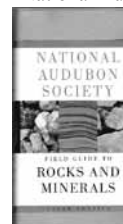

MINERAL SPECIMENS

HUBBARD SCIENTIFIC ROCK & MINERAL SAMPLE SETS

Excellent reference collection and a valuable aid in identifying and comparing common, and rare rocks and minerals. These mounted collections display and identify common minerals and igneous, sedimentary and metamorphic rock. Each set is attractively boxed and includes a 15 page book, "Rocks and Minerals A Study Guide".



#-3024 24 specimens **\$20.00**
 #-3025 50 specimens **\$30.95**
 #-3026 100 specimens **\$64.95**

FLUORESCENT MINERALS COLLECTION

This expanded collection allows a study in detail of the response of these minerals to ultraviolet light. Some respond to shortwave, some to longwave and some to both. Kit is 7 inches x 11 inches with 15 samples of minerals. The mineral samples are about 1 1/2" x 1 1/2". By Hubbard Scientific.

#-3022 **\$40.00**

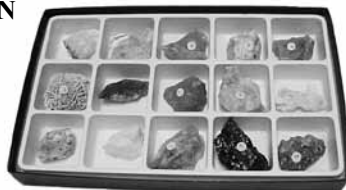

OUR BEST SELLING BOOKS ON

WHERE TO FIND GOLD

State Gold & Gem Maps Then and Now (Map Sets)

Detailed state maps showing where to find gold and gems. Including old mining district maps. Several maps per set for each state.

| | | |
|--------|-----------------|----------------|
| #-4011 | Arizona | \$12.95 |
| #-4019 | California, No. | \$12.95 |
| #-4021 | California, So. | \$12.95 |
| #-4024 | Colorado | \$12.95 |
| #-4013 | Idaho | \$12.95 |
| #-4028 | Montana | \$12.95 |
| #-4022 | Nevada | \$12.95 |
| #-4029 | New Mexico | \$12.95 |
| #-4015 | Oregon | \$12.95 |
| #-4031 | Utah | \$12.95 |
| #-4017 | Washington | \$12.95 |



GOLD YOURS FOR THE TAKING

It's about getting more of your share of desert gold. Highlights little known, remote placer sites, prospecting on a budget, use of the high-banker and the mini-sluice. Pictures and maps. Wielgus, 125 pages. #-5439 **\$18.95**



COLORADO PLACERS AND PLACERING

This partial reprint of Colorado Geological Survey Bulletin #33 covers 32 different areas of the state where placer deposits are found. Includes topo maps. Parker Jr., 112 pages. #-5471 **\$11.95**

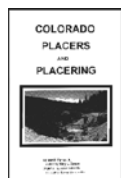

ARIZONA GOLD TREKS

Join the author as he travels the Arizona desert in search of hidden gold placers. If you have read his Arizona's Golden Secret, Yours For The Taking, and Arizona's Little-Known Gold Placers, you have the knowledge needed to find these undiscovered placers. Now it's time to put that knowledge to use. Finding your own hidden gold placer won't be easy but imagine discovering a gold placer no one else has found before. Ronald S. Wielgus, 95 pages. #6764 **\$15.95**



ARIZONA GOLD PLACERS AND PLACERING

To be reprinted. Originally an Arizona Bureau of Mines publication of placer areas in each county. Contains section on small scale placering. Wilson, 148 pages. #-6048 **\$9.95**

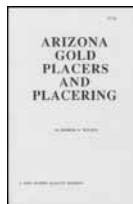

ARIZONA'S LITTLE-KNOWN GOLD PLACERS

The author acts as a personal guide for getting the prospector off the beaten path by supplying photos and directions to lesser-known placers throughout the state. Wielgus, 128 pages. #-5452 **\$22.95**

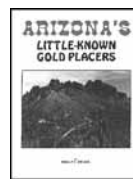

Placer Gold: Where to Find It

Locating a placer gold pay streak is not an easy task. The author imparts ten years of experience to help you do just that and then shares techniques of using the basic tools of prospecting. The use of the gold pan and sluice are covered. Gregory V. Stone, 61 pages, soft cover, 5 1/2 x 9 inches. #-5457 **\$10.95**



PLACER GOLD DEPOSITS OF,,, Original Geological Survey Bulletins. Authoritative guides to placer gold locations. Maps of placer gold deposits are included.

PLACER GOLD DEPOSITS OF ARIZONA

Original Geological Survey Bulletin - Authoritative guide to placer gold locations. A 20 x 20 inch removable map of the placer gold deposits of Arizona is included. Maureen Johnson, 103 pages, 5 1/2 x 8 1/2 inches, soft cover. #-5446 **\$9.95**



PLACER GOLD DEPOSITS OF NEW MEXICO

Original Geological Survey Bulletin - Authoritative guide to placer gold locations. Maps of placer gold deposits are included. Maureen Johnson, 46 pages, 5 1/2 x 8 1/2 inches, soft cover. #-5340 **\$7.95**



HOW TO READ A RIVER DVD:

Reading a River for Placer Gold Deposit Concentrations. Join ICMJ's Prospecting and Mining Journal Writer, Chris Ralph, as he explains where gold is most likely to concentrate along a river. See dredge operations that have used these rules of thumb to get in some rich pockets. Plus, you will see some spectacular underwater video of trout benefiting from these operations. #-8108 DVD **\$11.95**



WHERE TO FIND ARIZONA'S PLACER GOLD

Delos Toole has written this fine book to help you locate places that are known to produce placer gold. Includes detailed maps and exact directions to these areas. Detailed information is provided on ninety one different placer areas that are listed by counties. Delos Toole, 146 pages, soft cover, 8 1/2 x 11 inches. #-5338 **\$22.95**

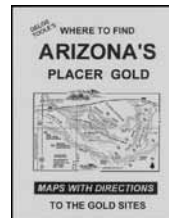

WHERE TO FIND GOLD IN CALIFORNIA

Locate places that are known to produce placer gold. Includes detailed maps and exact directions to these areas. Lots of old mine locations, hand drawn maps with points of interest to the gold fields and geological information of localities in California. Delos Toole, 141 pages, 8 1/2 x 11 inches, with a soft cover. #-6037 **\$22.95**



WHERE TO FIND GOLD IN OREGON

Locate places that are known to produce placer gold. Includes detailed maps and exact directions to locations for sniping, dredging, panning and beach placers. Lots of old mine locations, hand drawn maps with points of interest to the gold fields and geological information of localities in Oregon. Delos Toole, 144 pages, 8 1/2 x 11 inches, with a soft cover. #-5500 **\$22.95**



Gold Nugget-Teering In Nevada

Delos Toole's guide book to help you locate places that are known to produce placer gold and big nuggets in Nevada. Includes detailed maps and exact directions to these areas. Delos Toole, 138 pages, 8 1/2 x 11 inches, with a soft cover. #-6783 **\$22.95**



Gold Nugget-Teering In Northern California

Delos Toole's guide book to help you locate places that are known to produce placer gold and big nuggets in Northern California. Includes detailed maps and exact directions to these areas. Delos Toole, 140 pages, 8 1/2 x 11 inches, with a soft cover. #-6784 **\$22.95**

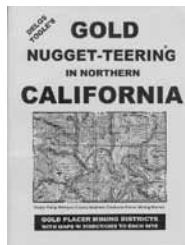

ANCIENT RIVER OF GOLD

How gold deposits are formed and where they can be found. Includes California, British Columbia, the Yukon and Alaska. Maps. Wallace, 122 pages, 8 1/2 x 11 inches, with a soft cover.

#-5280 \$19.95



Mining Districts and Mineral Resources of Nevada

Features information on past operations, the nature of the mineral deposits, and the geology of Nevada. Many maps are included. Lincoln, 259 pages.

#- 5364 \$19.95

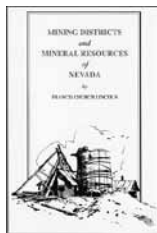

WHERE TO FIND GOLD IN THE DESERT

Expanded and updated edition of a classic best-seller. Desert gold locations in Nevada, New Mexico and Utah have been added. Locations in California and Arizona have been updated. New maps make locating areas easy. Chapter on nugget shooting details recent changes. Klein, 144 pages.

#-5311 \$9.95

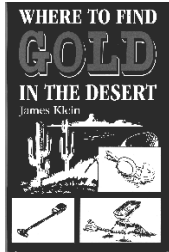

WHERE TO FIND GOLD IN THE MOTHER LODE

Interesting account of the California gold rush with camp sites, ghost towns and the geology of gold sites. Maps. Klein, 129 pages.

#-5312 \$9.95



Where To Find Gold In Northern California

This is a true guided tour of the mother of all gold producing areas. This is a great introduction to these gold bearing areas. Authentic and interesting reading for any gold seeker or history buff. Well illustrated, and loaded with old photographs and maps. James Kline, 153 pages, 5 1/2 x 8 1/2 inches, soft cover.

#-6575 \$10.95



GOLD DIGGERS ATLAS

Complete book of maps showing where gold has been found in the western United States. 64 pages. Johnson.

#-5293 \$7.50

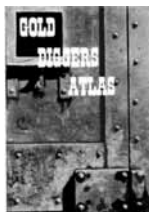

The Elusive "Pocket Gold" of South Western Oregon

How and where to pan, sluice, and dredge without a claim in the Oregon Cascades. This volume focuses on where and includes lots of detailed maps. Tom Bohmker, 86 pages 8 1/2 x 11 soft cover.

#-5257 \$17.50

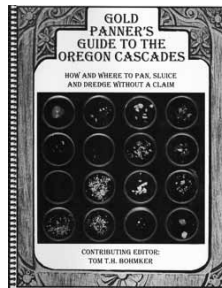

The Elusive "Pocket Gold" of South Western Oregon

Complete coverage of the subject of searching for pocket gold along with the tools and techniques to be successful. The tools and techniques covered here will be of interest and value to prospectors anywhere and especially those prospecting in Southwest Oregon.

Tom Bohmker, 82 pages 8 1/2 x 11 soft cover.

#-5256 \$17.50

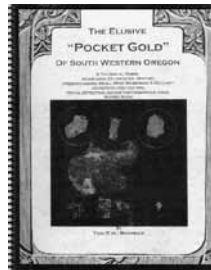

Under Water Sniping For Gold

The author includes plans to build many of the tools he uses. The book covers much more than sniping with sections on how to read rivers and streams to determine where the gold is, cleaning your finds, and selling your gold. It also has a section of detailed maps of areas to snipe for gold. Sam Radding, 144 pages with a soft cover.

#-5239 \$11.95

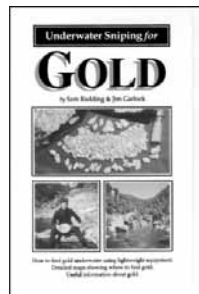

WHERE TO FIND GOLD & GEMS IN NEVADA

Maps and descriptive text on each country show historic and current mining sites and what gems can be found at each site. Photos. Klein, 109 pages.

#-5435 \$8.95

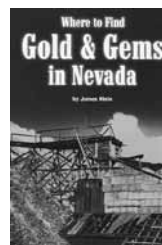

WHERE TO FIND GOLD IN SOUTHERN CALIFORNIA

This edition has all new maps and an added chapter on the Kern River area. Good introduction to the gold bearing areas. Authentic and interesting reading for any gold seeker or history buff. Illustrated.. Klein, 112 pages.

#-5212 \$9.95

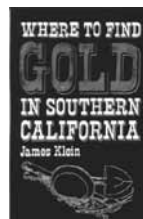

Geology

Field Geology Illustrated Revised 2006

An excellent field reference to aid in recognizing, interpreting and describing geologic features at the outcrop. Includes detailed descriptions, illustrations and photographs of geologic features in the field setting. Contains hundreds of B/W photos, each accompanied by an introspective sketch and detailed description. Terry S. Maley, 704 pages, 5 1/2 x 8 1/2 soft cover.

#-6268 \$35.00

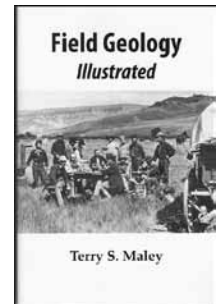

The Field Guide to Geology: Updated Edition

An excellent basic reference to the ingredients and processes that forged our planet. Includes 500 detailed and easy-to-understand two-color maps, charts, illustrations and photos. David Lambert, 256 pages, 7 x 9 soft cover.

#-5265 \$16.95

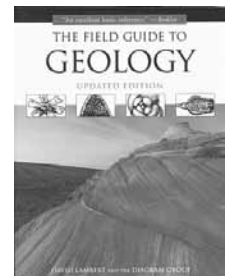

The Practical Geologist

The introductory guide to the basics of geology and to collecting and identifying rocks. Packed with more than 200 full-color illustrations and photographs. There are also sections on mapping, preparing, and curing specimens. Douglas Dixon, 160 pages, 8 x 10 inches with a soft cover.

#-5259 \$16.99

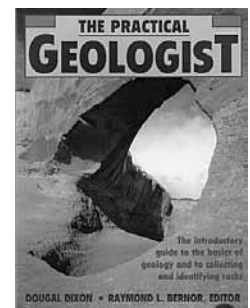

Dictionary of Geological Terms 3rd Edition

This best selling dictionary contains over 1000 terms. Find accurate definitions without technical jargon. Includes geological and life time line charts. Robert Bates and Julia Jackson, 572 pages with a soft cover.

#-5260 \$18.95

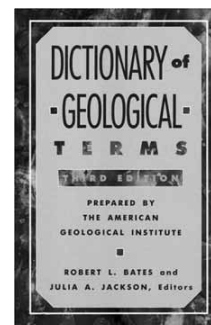

ROCK TUMBLERS

LORTONE ROCK & BLACK SAND TUMBLERS: These rock / black sand tumblers can be used by rock hounds to polish rocks; can be used by a detectorist to clean coins, or by prospectors to clean and amalgamate black sand. These units have LORTONE patented molded rubber barrels with quick-seal closures. The powerful 110 volt motors are continuous duty and fan cooled. Each is quiet, simple to operate, and gets excellent results. One year limited warranty.



| Barrel Capacity | Stock # | Price |
|-----------------|---------|----------|
| 3 pounds | #-5090 | \$89.00 |
| 4 pounds | #-6377 | \$132.00 |
| 6 pounds | #-5093 | \$189.00 |
| 12 pounds | #-5105 | \$210.00 |

MULTIPLE BARREL TUMBLERS: These units have two or three barrels on one base. Allows you to speed up the tumbling process by running multiple grits at the same time or to run multiple types of material at the same time

| Barrel Capacity | Stock # | Price |
|-------------------|---------|----------|
| Three 1 1/2 pound | #-6383 | \$135.00 |
| Two 3 pound | #-5091 | \$132.00 |
| Two 6 pound | #-5046 | \$225.00 |

What size are the barrels?

1.5 pound is 2 5/8" deep and 3 7/8" diameter
 3 pound is 4 1/8" deep and 3 7/8" diameter
 4 pound is 3 1/2" deep and 5 3/4" diameter
 6 pound is 3 5/8" deep and 6 3/4" diameter
 12 pound is 7 1/2" deep and 6 3/4" diameter
 These are the inside dimensions of the barrel.

LORTONE TUMBLER PARTS

| Stock# | Fits | Cost |
|--|---|--------|
| Drive Belts | | |
| #-6630 | 1 1/2 & 3 pound | \$1.85 |
| #-6631 | (2) 3 pound (3) 1.5 pound 4 pound | \$2.25 |
| #-6632 | 6 & 12 pound | \$6.50 |
| Inner Lid (aluminum with bolt) | | |
| #-6633 | 1 1/2 & 3 pound | \$3.90 |
| #-6634 | 4 pound | \$6.95 |
| #-6635 | 6 & 12 pound | \$7.95 |

| | | |
|--------------------------------|-----------------|--------|
| Inner Lid Rubber Gasket | | |
| #-6636 | 1 1/2 & 3 pound | \$4.65 |
| #-6637 | 4 pound | \$5.80 |
| #-6638 | 6 & 12 pound | \$7.20 |

| | | |
|---------------------------|-----------------|--------|
| Outer Aluminum Lid | | |
| #-6639 | 1 1/2 & 3 pound | \$4.70 |
| #-6640 | 4 pound | \$6.95 |
| #-6641 | 6 & 12 pound | \$8.95 |

| | | |
|--------------------|-------------|--------|
| Knurled Nut | | |
| #-6642 | All Barrels | \$1.95 |

| | | |
|---------------------------|--------------|---------|
| Replacement Motors | | |
| #-6644 | 3 & 4 pound | \$28.50 |
| #-6645 | 6 & 12 Pound | \$65.00 |

REPLACEMENT BARRELS FOR LORTONE TUMBLERS

These are complete Lortone tumbling barrels including the barrel, inner lid with liner and the outer lid with knurled nut.

| | | |
|--------|--------------------|---------|
| #6440 | 1 1/2 pound barrel | \$26.75 |
| #-6441 | 3 pound barrel | \$31.75 |
| #-6442 | 4 pound barrel | \$44.00 |
| #-6443 | 6 pound barrel | \$59.25 |
| #-6444 | 12 pound barrel | \$75.75 |

3 Pound Rock Tumbler Kit

TUMBLER-GRIT-ROCKS-INSTRUCTIONS

Complete tumbler-polisher kit. Includes pieces of rough agate, and everything you need to turn them into beautiful polished stones. With the rough stones the kit includes the Lortone 3 pound quality tumbler, a pre measured set of 4 grits and the Lortone tumbling guide. Fun, fascinating and educational. See above on this page for a detailed description of the tumbler.

#-6439

\$99.95 LORTONE TUMBLER



RAYTECH TV-5 Vibratory TUMBLER

Thousands of satisfied customers testify to the durability and simplicity of the Tumble-Vibe 5. Comes complete with an eight inch bowl, that will hold

about four pounds of rock, and a clear lid.

Capacity is about 1/2 cubic foot.

#-7110 **\$106.95**

RAYTECH TV-5 Starter Kit

Mated with a spare bowl, and a GS-H2 Stone finish kit, the new TV-5 Starter Kit is a must for any beginner. This new kit comes complete and ready to operate with a motorized base, two (2) bowls, clear lid, (2) rubber nuts and all the grits necessary for accomplishing the grinding step through the final polish step of most gemstones. This kit comes with everything you need to start except the rocks.



#-7120 **\$146.95** *Rocks are not included.*

JOBE COIN CLEANING KIT

Use this Lortone 3 pound tumbler with the supplies that are included to clean hundreds of clad coins so that you can take them to the bank. This kit includes the 3 pound tumbler, tumbling media, tumbling compound and instructions.

#-6448 **\$94.95**



ROCK TUMBLING GRITS & ACCESSORIES

Four stage grit packs premeasured for our smaller tumblers. Each pack includes coarse, medium, pre-polish and polish stages.

| STOCK # | BARREL SIZE | PRICE |
|---------|-------------|--------|
| #-6451 | 3 pound | \$8.95 |

BULK TUMBLING GRITS

Same tumbling media as above except packed in 1 pound packages of coarse, medium, pre-polish and polish. Sold per 1 pound pack.

| | | |
|--------|--------------------|---------|
| #-6456 | 1 pound coarse | \$6.95 |
| #-6457 | 1 pound medium | \$6.95 |
| #-6458 | 1 pound pre-polish | \$6.95 |
| #-6459 | 1 pound polish | \$10.95 |

BULK GRIT PACK

Includes one pound each of the coarse, medium, pre-polish and polish grits.

#-6445 \$29.95

BURNISHING COMPOUND

Used optionally after the polish stage this product quickly adds extra depth and luster to the polish on stones.

#-6463 1/2 pound \$4.95

#-6465 1 pound \$8.95

PLASTIC CUSHION BEADS

Small solid plastic beads used to cushion stones in the final polish stage, to polish placer gold and to fill short loads of stones. These are sold in 1 pound and 5 pound packages and are reusable.

#-6460 1 pound pack \$5.95

#-6461 5 pound pack \$22.95

How You Can Cut and Polish Gems Into Valuable Jewels

These are the secrets of the pros covering 80 major gemstones, cabinet specimens, faceting, cabochons and carving. With information sections on how to get started, types of equipment and compounds for the processes of shaping, polishing and jewelry making of over 80 natural/synthetic gemstones. Thirty two exclusive guide charts for accessories, diamond blades, discs, pads, wheels and polishing compounds. Also with dozens of other guidelines and tips for the beginner, novice, hobbyist and professional alike. Edward E. Smith, 5 1/2 x 8 1/2 inches, soft cover with 98 pages. #-3802 \$19.95



HOW TO TUMBLE POLISH GEMSTONES AND MAKE TUMBLED GEM JEWELRY

Detailed instructions for using a rock tumbler to polish rocks and how to create jewelry.

Jerome Wexler 31 pages.

#-5346 \$6.50

Gem Tumbling & Baroque Jewelry

Making: A simple guide for the rockhound who wants to tumble-polish their own stones. Features step-by-step practical advice with tips on handling various types of material including obsidian. Instructions on building your own rock tumbler are included with ideas on using simple household items as tumbling barrels. Earl and Lila Mae Victor, 6 x 9 inch soft cover with 58 pages. #-5345 \$6.50



HOW TO TUMBLE POLISH ROCKS INTO GEMS

3rd Edition

The mother of all tumbling books. This covers everything from soup to nuts to give you perfectly polished results. During the authors 40 years of experience he has processed thousands of pounds of material. Covers both rotary and vibratory tumblers. Edward E. Smith, 102 pages. #-5885 \$22.95



Jewelry Making For Fun and Profit

Learn the elegant art of jewelry making. This book was compiled with two goals in mind. Those are to teach you the basics of this fun craft and to show you how to turn these skills into cash. Includes detailed examples of projects. Musante and Nerius, 8 x 9 inches, 342 pages with a soft cover. #-3807 \$19.99



Basic Jewelry Making Techniques

Soldering, using wire, texturing, setting stones, enameling, casting, engraving, forging, and working with gold. Learn every aspect you need to know to get started or to increase your skill level. All the techniques needed to produce original pieces are explained with precise notes and illustrations. Loaded with full-color photography. Jinks McGarth, 112 pages, 9 x 12 inches with a soft cover. #-3806 \$24.99



Jewelry Making Techniques Book

A guide book for blending over 50 simple techniques such as cutting, forming, casting and stone setting with more sophisticated methods of creating eye-catching jewelry. Elizabeth Oliver, 8 1/2 X 11 inches, 128 pages with a soft cover. #-3805 \$22.99



HOFFMAN'S ROCKHOUND GUIDE

This is an unusual book covering a variety of subjects from gem stone identification to gold panning. Includes a very interesting section on rock tumbling techniques that you will not find anywhere else. There is also a section on making jewelry from your tumbled stones. Hoffman, 100 pages. #-5381 \$9.95

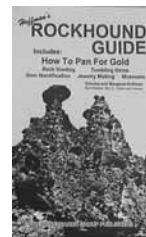

LORTONE TUMBLING INSTRUCTIONS

Easy to follow instructions to perfect tumbled stones.

#-5891 \$3.50

INTRODUCTION TO LAPIDARY

This is our best general lapidary book. An authoritative introduction to all aspects of lapidary is provided here. She describes the processes, tools and equipment of each branch of this fascinating hobby. Covers everything including rock tumbling, making cabochons, carving gem materials, lapping, cutting spheres, making beads and faceting. By Pansy d. Kraus with 196 pages, 7 1/4 x 9 inches soft cover. #-3801 \$21.95



Profits In Lapidary

A complete guide of practical tips and methods that can help hobbyists and professionals realize a splendid, dependable income from gem cutting. All the tips of the trade from purchasing raw materials, setting up your shop to marketing the finished products to individuals and to the trade. Gerald L. Wykoff CSM GG, 197 pages, 6 x 9 inches with a soft cover. #-3804 \$19.95



Jewelry Making Tips and Tricks of the Trade

An invaluable and comprehensive introduction to the basic skills of jewelry making that makes creating professional quality jewelry an easy to learn process. Using inexpensive material, more than 30 stunning projects are included, with every technique clearly photographed, and likely pitfalls explained. Stephen O'Keeffe, 7 1/2 x 9 1/2 inches with a soft cover, 128 pages. #-3803 \$24.99



Where to Find Rocks & Minerals

COLORADO ROCKHOOUNDING

Covers more than 350 collecting sites, with an overview of the state's geologic origins and mining history. Illustrated with maps and B/W photos. Voynick, 392 pages. #-5804 **\$20.00**

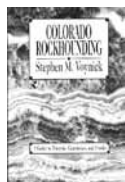

GEM TRAILS OF OREGON

Pinpoints directions to 55 well-known and little explored mineral sites throughout the state. Includes section on Oregon beach collecting. Mitchell, 120 pages. #-6243 **\$14.95**

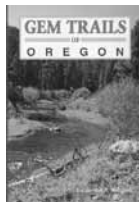

GEM TRAILS OF ARIZONA

Completely revised edition of this essential guide for the Arizona rockhound. Contains 23 additional new trails, improved maps, eight-page, four-color insert of specimen photos, along with detailed information on where to go and what to look for. Index by location and by mineral. Mitchell, 184 pages. #-5229 **\$14.95**



GEM TRAILS OF COLORADO

This detailed guide to the best that Colorado has to offer has been completely revised and updated. Includes ten new sites and a color section picturing the wide diversity of gems and minerals available throughout the state. From blue barite to topaz, numerous maps lead the collector along the gem trails. Mitchell, 144 pages. #-6244 **\$12.95**



GEM TRAILS OF WASHINGTON

This is the first comprehensive collecting guide of its kind for the Evergreen State, covering all four corners, from the shores of the Olympic peninsula to the ghost towns and abandoned mines near Metline Falls. Washington's diverse geology, ranging from fossil-rich Cambrian locales to seams of agate and jasper amid recent basalt flows, is explored in great detail. Over 75 sites are presented with directions, maps, GPS readings, numerous photos, descriptive text and mineral locator index and glossary. Romaine, 200 pages. #-6239 **\$14.95**

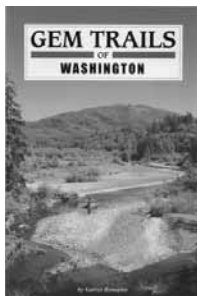

GEM TRAILS OF NEW MEXICO

New Mexico is a rockhound's paradise. From micro-mount and gem quality mineral specimens to fossils. Updated and revised edition contains informative text and maps for 65 trails, including 15 new sites, new photos, and a beautiful color insert highlighting the variety of minerals found in New Mexico. Mitchell, 160 pages. #-6241 **\$12.95**



GEM TRAILS OF NEVADA

Maps photos and detailed text describe where to go and what to look for at over 50 sites throughout the state of Nevada. Includes mineral locator index. Mitchell, 119 pages. #-5232 **\$14.95**

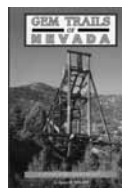

GEM TRAILS OF TEXAS

Popular guide to Texas gems trails. Includes 46 of the best sites in the state. Maps, photos and clear, exact directions include what to look for at each site. Mitchell, 167 pages. #-6245 **\$12.95**



GEM TRAILS OF UTAH

Welcome to rockhounding in Utah. This is the latest edition of the classic best selling guide. The gem hunter is lead to landscapes as diverse as the gems, minerals and fossils found there. B/W photos highlight the collecting areas. A special color section aids in the identification of specimens. Mitchell, 168 pages. #-6240 **\$12.95**

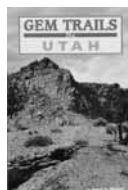

GEM TRAILS OF PENNSYLVANIA AND NEW JERSEY

Leads the collector to over 47 sites where beautiful mineral specimens and fossils can be found. Authoritative text includes information on equipment, clubs and tourist attractions. B/W photos, detailed maps, and a striking color insert will entice the reader to "hit the trail". Stepanski & Snow, 160 pages. #-6242 **\$12.95**



GEM TRAILS OF SOUTHERN CALIFORNIA

The definitive guide to over 70 of the best collecting sites for gems, minerals and fossils in Southern California from San Luis Obispo to San Diego. Detailed maps, text, and B/W locale photos lead the way and vivid color photos of specimens excite the anticipation of great finds. Mitchell, 184 pages. #-5267 **\$12.95**



GEM TRAILS OF NORTHERN CALIFORNIA

This most complete guide to Northern California features sites from the Oregon border south to San Luis Obispo. Beautiful color photographs showcase the specimens that can be found at the sites described. Detailed text and maps make locating collecting areas easy. Mitchell, 160 pages. #-5480 **\$12.95**



MIDWEST GEM, FOSSIL AND MINERAL TRAILS: Great Lakes States

How and where to find materials in Michigan, Ohio, Illinois, Indiana, Wisconsin, and Minnesota. Includes maps and photos. Zeitner, 96 pages. #-6266 **\$10.95**



MIDWEST GEM, FOSSIL AND MINERAL TRAILS: Prairie States

Covers Kansas, Nebraska, Missouri, North Dakota, South Dakota, and Iowa. Maps descriptions and many B/W photos. Zeitner, 104 pages. #-6284 **\$10.95**

FALCON GUIDES STATE ROCKHOUND SERIES

Informative guides to collecting areas featuring maps, detailed directions, and advice on field techniques. 9 inch x 6 inch with a soft cover.

ROCKHOOUNDING ALASKA

Hodges, 221 pages. #-6810 **\$16.95**

ROCKHOOUNDING ARIZONA 2nd Edition

Blair, 217 pages. #-6253 **\$16.95**

ROCKHOOUNDING CALIFORNIA 2nd Edition

Butler, 200 pages.

#-6248 **\$14.95**

ROCKHOOUNDING COLORADO 2nd Edition

Kappele, 244 pages.

#-6250 **\$14.95**

ROCKHOOUNDING IDAHO

Romaine, 253 pages.

#-6811 **\$16.95**

ROCKHOOUNDING MONTANA 2nd Edition

Feldman, 218 pages.

#-6254 **\$14.95**

ROCKHOOUNDING NEVADA 2nd Edition

Krapele, 240 pages.

#-6262 **\$15.95**

ROCKHOOUNDING NEW MEXICO

Vaskys & Freed, 257 pages.

#-6251 **\$15.95**

ROCKHOOUNDING UTAH

Kappele, 180 pages.

#-6252 **\$12.95**

ROCKHOOUNDING WYOMING

Graham, 176 pages.

#-5815 **\$14.95**

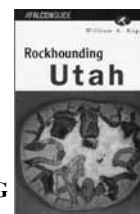
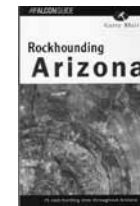

Coast to Coast Gem Atlas

Overview maps of gem finding locations throughout the Continental U.S. This is the Revised 5th Edition and includes site information for rocks and minerals, and local rock shops. Robert N. Johnson, 60 pages, 8 1/2 x 11 with a soft cover. #-5801 **\$11.50**

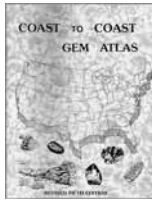

Minerals, Fossils, and Fluorescents of Arizona

This entirely new expanded guide is designed not only for the mineral collector but for fossil and fluorescent collectors as well. It includes 90 collecting sites with photographs, topographic maps, G.P.S. coordinates and difficulty scale for each site. Covers basic science of minerals, fossils and fluorescents, geological formations at each site and properties of minerals. With 20 full-color photographs of specimens by noted mineral photographer Jeffrey Scovil. Neil R. Bearce, 401 pages, 8 x 10 inches with a soft cover. #-5330 **\$29.00**



Idaho Minerals: The Complete Reference and Guide to the Minerals of Idaho 2nd Edition

Perfect for the amateur collector and professional mineralogist interested in the identification and location of minerals in the state of Idaho. This comprehensive guide gives mineral descriptions, collection areas, and is illustrated throughout with color photos. Lanny R. Ream, 371 pages, 6 x 9 inches with a soft cover. #-4316 **\$27.95**



Guide to Rocks & Minerals of the Northwest

Many color photographs and explanations of many of the prized rocks and minerals of the Pacific Northwest states and western Canada. Stan and Chris Leaming, soft cover with 33 pages. #-4313 **\$5.95**



Rocks and Minerals of California

An indispensable field guide with a general description of the types of rocks and minerals found in California and the type of geology in which they occur. This is followed by a section of general maps of the state outlining the types of rocks that will be encountered in those areas. Full-color photographs of 48 rocks and minerals found in California. This is followed by a section with information on hundreds of USGS quadrangle maps and the location of gold, silver and other minerals by township, range and section number. Vinson Brown, David Allan and James Stark, 200 pages, 5 1/2 x 9 inches with a soft cover. #-5258 **\$13.95**



Traveler Guidebooks

Striking full color guides, bound in water repellent, laminated covers. Extensive center-spread map of the state highlights the locations featured in the book.

Gems & Minerals of Arizona: A guide to native gemstones.

This is a handy pocket-sized guide to the native gemstones of Arizona. Lots of color photographs and a full color map of Arizona with collection areas. Panczner, 48 pages, 4 x 9 inches with a soft cover. #-5477 **\$6.95**



Gems & Minerals of California: A guide to localities.

This is a handy pocket-sized guide covering California from the northern volcanic regions to the southern deserts. California is divided into seven geological regions and each region is discussed along with the types of rock and minerals that can be discovered. William Estavillo, 48 pages, 4 x 9 inches with a soft cover. #-5274 **\$6.95**

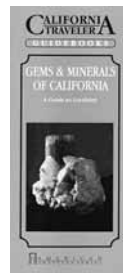

The GPS GUIDE TO WESTERN GEM TRAILS Revised

Compiled by a veteran rockhound, this handy supplemental GPS guide directs you to the best collection sites found in the Gem Trails books series as well as other popular rockhounding guides. Covers the states of Arizona, California, Colorado, Idaho, Montana, Nevada, New Mexico, Oregon, Utah, Washington and Wyoming. Includes the lat/lon coordinates of each site along with the Delorme map page number, section/township/range information, and the name of the USGS 7 1/2 minute quadrangle for each site. This is a 6" x 9" soft cover by David Kelty, with 294 pages. Revised in 2011. #-5207 **\$19.95**

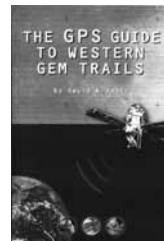

The Rockhound's Handbook

Learn about rock and mineral formation, tools, identification, finding minerals in the field, legal aspects, preparation and preservation, cutting and polishing, and making jewelry. Numerous B/W photos and illustrations with color photos of 90 of the most commonly encountered minerals. James R. Mitchell, 299 pages, 6 x 9 inch with a soft cover. #-6255 **\$15.95**

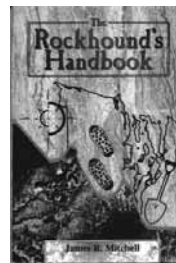

Treasure Hunters Gem & Mineral Guide Series

Newly revised these guides offer state-by-state details on more than 250 gems and minerals the U.S. has to offer and affordable fee-dig sites where they can be found. Includes maps, illustrations and B/W photographs.

Northeast Treasure Hunter's Gem & Mineral Guide 3rd edition Updated & Expanded

Where and how to dig, pan and mine your own gems and minerals in the Northwestern States. This guide offers you an easy to use guide to "fee dig" mining, complete with locations, costs, tips on technique, entertaining legends and other important information. Kathy J. Rygle and Stephen F. Pedersen. Soft cover with 208 pages, 5 1/2 x 8 1/2 inches. #-6801 **\$14.99**

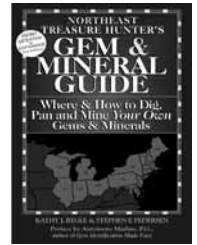

Northwest Treasure Hunter's Gem & Mineral Guide 3rd edition Updated & Expanded

Where and how to dig, pan and mine your own gems and minerals in twelve Northwestern States. This guide offers you an easy to use guide to "fee dig" mining, complete with locations, costs, tips on technique, entertaining legends and other important information. Kathy J. Rygle and Stephen F. Pedersen. Soft cover with 176 pages, 5 1/2 x 8 1/2 inches. #-6800 **\$14.99**

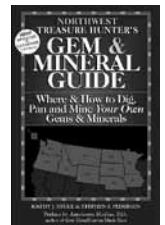

Southeast Treasure Hunter's Gem & Mineral Guide 3rd edition Updated & Expanded

Where and how to dig, pan and mine your own gems and minerals in 13 Southeastern States. This guide offers you an easy to use guide to "fee dig" mining, complete with locations, costs, tips on technique, entertaining legends and other important information. Kathy J. Rygle and Stephen F. Pedersen. Soft cover with 192 pages, 5 1/2 x 8 1/2 inches. #-6803 **\$14.99**

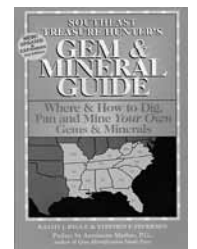

Southwest Treasure Hunter's Gem & Mineral Guide 3rd edition Updated & Expanded

Where and how to dig, pan and mine your own gems and minerals in 10 Southwestern States. This guide offers you an easy to use guide to "fee dig" mining, complete with locations, costs, tips on technique, entertaining legends and other important information. Kathy J. Rygle and Stephen F. Pedersen. Soft cover with 208 pages, 5 1/2 x 8 1/2 inches. #-6802 **\$14.99**

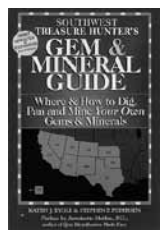

Fee Mining and Rock hounding Adventures

In The West: Updated and informative guide to over 90 collection locations. Includes museums, caves, points of interest and festivals throughout the western states. Seasons, days and hours of operation are included for each site as well as address, directions, cost, tools and supplies needed. Organized by state, it is an invaluable guide for the gold prospector or gem hunter. Martin and Jeannette Monaco, 240 pages, 8 1/2 x 11 inches with a soft cover. #4350 **\$15.95**



Fee Mining & Mineral Adventures In The Eastern U.S. This unique book is a treasure trove of interesting things to see and do relating to rocks, minerals, and other wonders of the world. With 270 sites listed in 31 states, from gold fields to caves and caverns, this guide will interest everyone, from experienced rockhounds and prospectors to families on vacation. Museums, regional attractions and camping information are also included. Martin and Jeannette Monaco, 264 pages, 8 1/2 x 11 inches with a soft cover. #4351 **\$15.95**



New Mexico Rocks and Minerals
Maps and descriptions of mining districts and mineral sites by county. Frank S. Kimbler & Narsavage, Jr. Soft cover with 72, 5 1/2 x 8 1/2 inch, pages. #6246 **\$8.95**

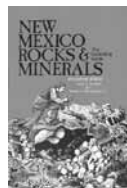

State Gold & Gem Maps Then and Now (Map Sets)

Detailed state maps showing where to find gold and gems. Including old mining district maps. Several maps per set for each state.

| | | |
|-------|-----------------|----------------|
| #4011 | Arizona | \$12.95 |
| #4019 | California, No. | \$12.95 |
| #4021 | California, So. | \$12.95 |
| #4024 | Colorado | \$12.95 |
| #4013 | Idaho | \$12.95 |
| #4028 | Montana | \$12.95 |
| #4022 | Nevada | \$12.95 |
| #4029 | New Mexico | \$12.95 |
| #4015 | Oregon | \$12.95 |
| #4031 | Utah | \$12.95 |
| #4017 | Washington | \$12.95 |



Desert Gem Trails: Revised

Field guide to the gems and minerals of the Mohave and Colorado Deserts in California and adjacent areas of Nevada. Includes maps and photos. Mary Frances Strong, 80 pages, 5 1/2 x 9 inches with a soft cover. #5805 **\$10.95**



Where to Find Gold and Gems in Nevada

Gold-bearing regions and selected gem and rockhound areas organized by county. Maps, photos, directions and interesting historical antidotes. James Klein, 110 pages, 6 x 9 inches with a soft cover. #5435 **\$8.95**



Books for Young Rockhounds & Prospectors

DK Eye Witness Books:

Crystal & Gem

For the beginning naturalist ages 10 and up - hundreds of real-life color photos and illustrations with lively captions and detailed text. These DK Eyewitness books have an attractive format that will keep the interest of young readers. Dr. R. F. Symes and Dr. R. R. Harding, 71 pages, 8 3/4 x 11 1/4 inches, hard cover. #5225 **\$15.95**



DK Eyewitness Rocks & Minerals

A big 9 x 11 hardcover with 72 photo packed pages, a rock and mineral clip-art CD, and a removable full color wall chart. Has an attractive format that will keep the interest of young readers. #4303 **\$16.99**



Usborne Spotter's Guide: Rocks & Minerals

Children's mineral identification guide for ages 7 and up. Pocket sized but packed with information. This field guide is loaded with full color pictures and illustrations to help you identify and understand rocks and minerals. Alan Woolley, 4 1/2 inches by 7 1/2 inches, soft cover with 64 pages. #4305 **\$5.95**

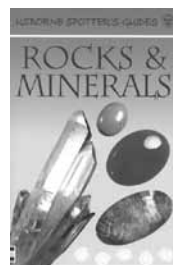

DK The Rock and Mineral Sticker Encyclopedia: Your child

can create their own picture book using these full-color stickers. This large, 8 1/2 x 11 64 page, volume also contains 16 pages of full color stickers containing over 600 stickers. The self-adhesive stickers can be peeled off and used more than once. The ultimate collection of rock and mineral stickers, ideal for home or school projects. #4349 **\$12.99**

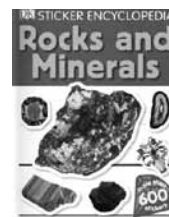

Extreme Rocks & Minerals

Designed for ages 5-9 by the Smithsonian with links to the Smithsonian web site. 8 x 10, full color illustrations and photographs catch and hold a child's interest while learning about rocks and minerals. How do people use minerals? What is a sedimentary rock? A fun Q&A format makes learning seem like more of a game. 48 pages with a soft cover #4310 **\$6.99**



DK ROCKS & MINERALS

EYE WONDER

Packed with facts, accessible text, and dramatic, atmospheric photography; this book is a great introduction to the fundamentals of earth science for young children 7 and up. Hard cover, 48 pages. #4354 **\$10.99**

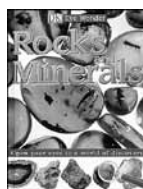

The Gold Rush: Life in The Old West

A great book for children learning about the California Gold Rush. Learn about life as a gold miner during the California and Klondike gold rushes. Historic photos and color illustrations show what life was like in the camps, mining techniques and the communities that resulted from the gold rush. Bobbie Kalman, 32 pages, 8 1/2 x 11 inches, soft cover. #4602 **\$7.95**



ESSENTIAL ATLAS OF FOSSILS & MINERALS

This information-packed atlas combines attractive photos and illustrations with lucid text to present a general overview of fossils and minerals from the differing perspectives of geology, paleontology and collecting. Bye, 96 pages. #4353 **\$10.95**

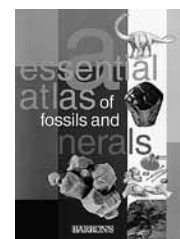

Camping

Pocket Fire Starter

This handy pocket sized tool can help you start a fire without matches in any kind of weather.

#-6373 \$4.95



Survival Knife with Fire Starter

This stainless steel survival knife is made from one piece of steel with a 4 inch blade and a lace handle. The web sheath has a separate pouch for the fire starter.

#-6375 \$9.95



The Modern Hunter-Gatherer:

It covers the basics of how to procure wild foods, small game, fish, and edible plants. The book is unique in that it covers both modern and primitive methods for living off the land that have been extensively tested out over the past twenty years of teaching survival courses- none of the recycled line-drawings found in most survival books. #-5310 \$16.95



Emergency

Emergency Survival Sleeping Bag

Made of polyester material designed from insulation used in space exploration. Can also be used as emergency ground cover or as a reflector. Waterproof and windproof. Bag size is 84 inches x 36 inches.

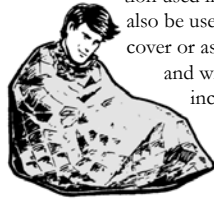

#-6516 \$3.95

Emergency Survival Blanket

Made of polyester material designed from insulation used in space exploration. Reflects 90% of body heat. Can also be used as emergency ground cover or as a reflector. Waterproof and windproof. Bag size is 84 inches x 52 inches. #-6510 \$1.95



G.I. STYLE FOLDING CAN OPENER

Key chain size, but very effective and sturdy. #-6216 \$.99

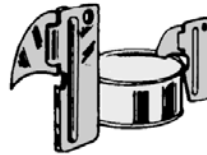

JOBE Plastic Cutting Board:

White plastic, 6 inch by 8 inch, 3/8 inch thick, provides a clean cutting surface.

#-6295 \$3.95



Survival

Magnificent Quest

Originally published in 1990 as a guide to those who prospect and metal detect in the arid southwest deserts of the western United States. It's main purpose is to give basic tips on staying comfortable and safe where the only shade is your shadow. Revised in 2009 and expanded with color photos. Jim Straight, 76 pages, 6 x 9 inches with a soft cover. #-4043 \$9.95

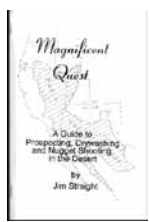

Desert Survival Handbook:

Increase your survival odds and improve your chances of rescue while you prepare yourself for emergencies. Charles Lehman, 90 pages, 5 1/2 x 8 1/2 inches with a soft cover. #-5334 \$8.95

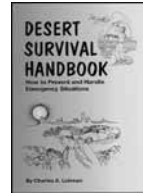

Emergency Survival: a pocket guide:

Offers the necessary steps to surviving a broad scope of emergency situations from broken bones, bleeding, and snakebites to heat exhaustion, frostbite, and hypothermia. A section on surviving in the wilderness offers direction on finding shelter from the cold, what to do if you get lost, procuring water and food, and building fires. All situations and solutions are presented in a concise, accessible manner. #-5325 \$3.50

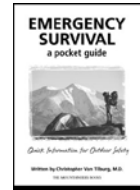

Desert Survival Tips, Tricks, & Skills:

Focuses on the specific skills needed for desert survival and safety. Few books on desert survival have ever contained such detailed examples of the fundamental skills necessary for traveling and hiking in the land of little water. #-5484 \$10.95

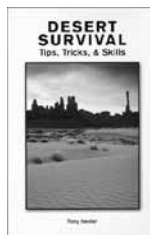

(DVD) Desert Survival

Tips, Tricks, & Skills: An expanded version of the book this 2 hour DVD covers everything the book does and more. #-6129 \$24.95

Emergency Poncho

A handy item to keep in your vehicle or back pack for weather emergencies. A full size adult plastic hooded poncho made of polyethylene. Measures 50" x 52" x 80" and is reusable. Comes folded in a pocket zip-lock bag. One size fits all. Weighs less than 2 ounces. #-6511 \$1.39



SNAKE GUARDZ SNAKE PROOF GAITERS

At work, at home, or enjoying your hobbies now you can have leg armor protection for your entire lower leg, ankle and upper foot. This unique system allows air to flow between your Snake Guardz gaiters and your leg, providing cool comfortable protection with unrestricted movement. Space age .028 inch thick impact-resistant poly carbonate inserts protect the front of your leg while .02 inch thick impact-resistant styrene inserts protect the sides and back of your leg. Weighing less than 7 ounces you barely know you are wearing them. One inch straps and quick release buckles maintain their fit without needing to be readjusted with each use.

These gaiters are available in three sizes .

The sizes are as follows: **Medium** fits 55 to 125 pounds. **Large** fits 125 to 225 pounds. **Extra Large** fits 225 pounds up. Mossy Oak Camo 1000 Denier water resistant nylon fabric.

#-6340 specify size M,L,XL \$69.95

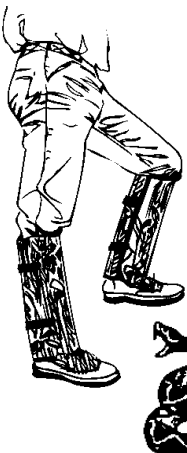

TOOLS & STUFF

JOBE LIGHT DUTY ROCK PICK

This forged steel 22 oz pick head is attached to a durable fiberglass handle for a good quality light duty rock pick.



JOBE 22 OUNCE ROCK PICK

This quality 22 ounce rock pick is made of drop forged steel. It is forged in one piece with continuous grain flow from head to shaft. The rubber grip is finger fitted, shock absorbent and nonslip.

#-5085 **\$24.95**



ESTWING SUPREME ROCK PICK

Estwing quality one-piece forged pointed tip rock pick. Full polish with nylon-vinyl grip.

#-5194 14 oz. **\$36.95**
 #-5195 22 oz. **\$37.95**



EXTRA LONG ESTWING ROCK PICK

Same 22 ounce hammer as above, but has extra long handle for more prying leverage and power.

#-5196 **\$44.95**



ESTWING LEATHER GRIP

Same as the Estwing 22 ounce rock pick above except with a deluxe leather handle.

#-5170 **\$38.95**



JOBE 22 Once Long Handle Rock Pick

This quality 22 ounce rock pick is made of drop forged steel. It is forged in one piece with continuous grain flow from head to shaft. The rubber grip is finger fitted, shock absorbent and nonslip. #-5142 **\$26.95**

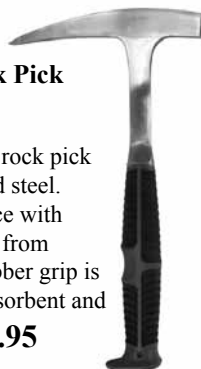

THE BOSS Detector Pick

A 4 1/2 inch wide x 9 inch hardened steel head attached to a 22 inch long American Hickory handle makes for a serious digging tool. Weighing only 2.3 pounds it is perfect for metal detecting.

#-5590 **\$59.95**



ESTWING GEO/PALEO PICK

The famous Estwing Pick has made a grand reentry after being out of production for several years. The handle has been beefed up to make the unit even stronger. This Bad Boy is 25 inches long with a total weight of 4 pounds.

Grey painted steel with a soft vinyl grip. #-5103 **\$65.95**



The Crack Jack

This is a quality 4 pound slide hammer. Perfect for gold prospecting or gem recovery. The unit is 22 inches long with a pointed chisel tip and a pry bar tip.

#-5200

\$43.95



Slide Hammer
Crevice Tool

LEATHER BELT SHEATH

Durable leather sheath for Estwing and similar rock picks. #-5197 **\$8.95**

Will not work with the Light Duty Rock Pick #-5141

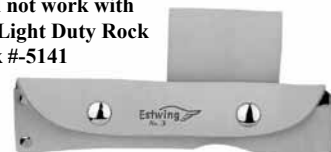

SWIVEL LEATHER HAMMER HOLDER

Works on all the detector hammers. #-6028 **\$2.98**

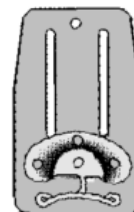

HAMMER / PICK HOLDER

Specially designed to work with all detector picks especially with super magnets. This heavy black webbing material holds the hammer quietly and has no metal parts for the super magnet to grab.

#-5772 **\$7.50**

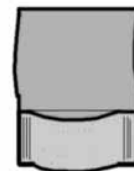

The Groundhog Detector Pick

Made in the USA this heavy duty detector pick has a hardwood handle with a rubber grip. The pick / mattock steel head is 9 inches long and 2 1/4 inches wide on the mattock side. The tool has an overall length of 18 inches and weighs only 1 3/4 pounds. A powerful super magnet is included and attached to the top of the tool.

#-5602

\$44.95



MORTARS & PESTLES

Compact but heavy duty the Mini Mortar has a 1/2 pint capacity. It is cast iron, stands 3 1/4" high, and weighs 5 pounds. #-5918 **\$29.95**

Our large mortar stands 5" high weighs 8 1/2 pounds and has a 1 pint capacity. #-5919 **\$39.95**



DOUBLE FOLDING SHOVEL

Tempered steel shovel fully extends to 23 1/2" and folds to a compact 9" x 6". Can be configured as a hoe, shovel, stool or root saw. All steel construction.



#-5056 **\$12.95**

SAFETY GLASSES

POLYCARBONATE SAFETY GLASSES

Safety glasses with polycarbonate lenses provide greater impact protection than tempered glass lenses. **These lenses are impact resistant but may break under severe impact.** Tested under American National Standard Institute ANSI Z87.1-1979 Approved. Made in Taiwan. #-6787 **\$3.95**



ESTWING SAFE-TY GOGGLES
#-5198 **\$3.95**

ALWAYS WEAR EYE PROTECTION WHEN USING STRIKING TOOLS.



Snappy Grip is the best product ever developed for fighting hand fatigue caused by uncomfortable bucket handles. The two halves of each Snappy Grip snap together to replace the handle over the wire bail on your buckets. Comes in a pack of 2 sets.

#-6831 **\$2.99**

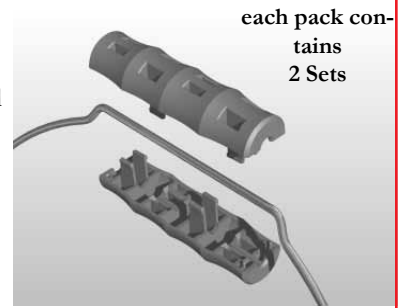

each pack contains 2 Sets

JOBE Treasure Pick / Mattock



#-5580

\$39.95

Super Magnet

When you need a little bit more serious digging tool for your prospecting, treasure hunting and metal detecting adventures. This drop forged steel head is 10 inches long and the mattock edge is 3 1/4 inches wide. The overall length is 19 inches with a durable fiberglass handle and a rubberized hand grip. A powerful super magnet is attached to the top of the tool to grab all those pesky junk iron targets. The total weight is about 2 pounds.

tool to grab all those pesky junk iron targets. The total weight is about 2 pounds.

PRY BAR / CREVICE TOOL SET

These hardened alloy steel pry bars are drop forged and then hardened to make perfect tools for attacking the toughest crevices. The set includes 6, 12, 16, and 19 inch bars.

#-6792 **\$14.95**



MINI SHOVEL / PICK

This sturdy miniature folding shovel is perfect for metal detecting, rock collecting and gold prospecting. With a two piece handle it easily breaks down into a compact kit. #-5694 **\$9.95**



- A** #-5008
- B** #-5009
- C** #-5010
- D** #-5011
- E** #-5012

WILCOX STAINLESS STEEL DIGGING TOOLS

For those who prefer heavy duty (MADE IN THE U.S.A.) construction with economic pricing. The handles cannot separate from the tool because they are constructed of one solid piece of stainless steel. These tools have a depth gauge inscribed on the back. Nonslip vinyl hand grip.

Wilcox Quality Digging Tools

- (A) #-5008 10" long x 3" wide **\$10.95**
- (B) #-5009 10" long x 1.5" wide **\$ 9.95**
- (C) #-5010 11" long x 3 in wide **\$13.25**
- (D) #-5011 12" long x 2 in wide **\$13.25**
- (E) #-5012 14" long x 3" wide **\$14.25**

TOOLS for SNIPING for GOLD

Under Water Sniping For Gold

True to its title it is the first book that covers the art of sniping for gold. Using inexpensive tools you can go after gold trapped in crevices in and out of the water. The author includes plans to build many of the tools he uses. The book covers much more than sniping with sections on how to read rivers and stream to determine where the gold is, cleaning your finds, and selling your gold. It also has a section of detailed maps of areas to snipe for gold. Sam Radding, 144 pages with a soft cover.

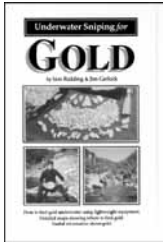

#-5239 **\$11.95**

STEEL CREVICE TWEEZERS

These big 12 inch long stainless steel tweezers are perfect for reaching into crevices to recover small gold nuggets.

#-6827 **\$4.95**



Economy Hand Guard Chisels

These economical cold chisels have a plastic hand guard. We get them from a number of manufacturers so the design varies a little. They are all 9 to 12 inches long with 5/8 to 3/4 inch shafts. Made in China.

(A) Splitting tip hand guard chisel. #-6017 **\$6.95**

(A) (B)



(B) Pointed tip hand guard chisel. #-6018 **\$6.95**

JOBE SNIPE SCOPE

The body of this viewing tube is aluminum with a clear plastic lens. The body is 4 inches wide and a little less than 11 inches long. Has a wood handle to insure ease of use. Allows you to see clearly through the surface of the water for sniping etc.

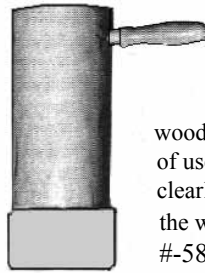

#-5825 **\$24.95**

GOLD BUDDY NUGGET SUCKER

Hand operated gravel extractor is made of 1 1/2 inch PVC pipe with an adjustable tension rubber plug. The T-handle is made of plated steel. Perfect for crevicing and sniping. Total length is about 30 inches. The vacuum chamber is 1 1/2 x 20 inches and the total weight of the unit is only 2 pounds.

#-6023 **\$37.95**



GOLD BUDDY

MAGNUM NUGGET SUCKER

Same as above only bigger. Made of 2 inch PVC pipe with an adjustable tension rubber plug. The T-handle is made of plated steel. Total length is about 36 inches. The vacuum chamber is 2 x 28 inches. Weighs a little over 3 pounds.

#-6025 **\$41.95**

JOBE Standard Steel Crevice Tool

16 inch long basic anodized steel crevice tool.

#-5112 **\$9.95**



SPOON TYPE CREVICE TOOLS

These anodized steel crevice tools are the best performing crevice tools we have ever carried. One end has a traditional awl type point for scratching into narrow crevices while the other end is configured like a spoon for removing material from larger crevices.

#-6469 10 inches long **\$9.95**

#-6468 12 inches long **\$11.95**

#-6467 16 inches long **\$13.95**



JOBE Premium Crevice Tool

This 20 inch long anodized crevice tool is constructed from steel with a hook on one end, and a spoon on the other. The spoon end is extremely handy for retrieving material from deep crevices.

#-6470 **\$16.95**



BEDROCK BRUSH

Wood handle and tough bristles make for a perfect bedrock brush to clean out shallow crevices and sweep up gold from exposed bedrock. Total length is 10 inches.

#-6464 **\$1.95**



MINI BEDROCK BRUSH

Same as item #-6464 except the brush is only 6 inches long. A handy little tool.

#-6960 **\$.98**

SUPER MAGNETS



Round Super Magnet

This powerful round super magnet is 1 inch in diameter and 3/8 inch thick with a hole in the center to attach it to digging tools with wood handles.

32 #-5920 **\$13.95**

Two 8 Pound Super Magnets

These 8 pound super magnets are a little smaller than a dime but much thicker. Each one will lift up to 8 pounds. Get them stuck together and it is difficult to get them separated.

#-5917 set of 2 magnets **\$5.49**



Four 3 Pound Super Magnets

These 3 pound super magnets are about 1/4 inch in diameter. Each one will lift up to 3 pounds. Get them stuck together and it is difficult to get them separated.

#-5913 set of 4 magnets **\$4.49**



PICK UP MAGNETS

JOB POCKET PLUNGER MAGNET

This powerful magnet is mounted in a tube shaped housing just a little larger than an ink pen. When the plunger is depressed the magnet picks up black sand and drops it off cleanly when the plunger is released.



#-6008 **\$7.95**

JOB " Top Hat " Black Sand Magnet

This is a world class prospecting tool. About twice as strong as any other magnet near it's size it is a powerful tool to remove unwanted magnetic black sand from your pan or concentrates.



#-6009 **\$8.95**

SERIOUS BLACK SAND MAGNET

The aluminum and plastic housing on this big (9 inches tall) black sand magnet allows loads of magnetic black sand to drop off cleanly when the plunger is lifted.



#-5671 **\$15.95**

POCKET MAGNETIC PICK UP TOOL

Great for getting rid of pesky iron targets without stooping. Uses a small super magnet. Pocket size telescopes to over 30 inches.

#-6683 Lifts 10 pounds **\$4.95**



15 POUND MAGNETIC PICK UP TOOL

Great for getting rid of pesky iron targets without stooping. Uses a powerful super magnet to lift up to 15 pounds. Pocket size telescopes to over 24 inches with a rubberized grip. #-6682 **\$8.95**



Big Orange Magnet

The Big Orange magnet is a must for picking up magnetic black sand from dredge or drywasher concentrates.

Works wet or dry. #-5912 **\$17.95**



STAKE YOUR CLAIM

JOB METAL CLAIM SIGNS: These aluminum claim signs are the perfect answer to a clear and inexpensive way to clearly mark your claims so that other prospectors can avoid them. They are bright yellow and professionally produced.

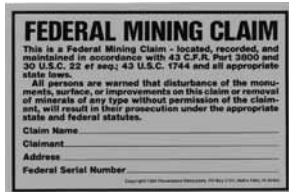

Federal Mining Claim Sign is 11 inches wide and 7 1/2 inches tall and makes it obvious that this is an active mining claim.

#-5866 **\$4.95**

The Corner Monument Sign is 3 3/4 inches square which makes it perfect for attachment to 4 x 4 corner post.

#-5868 **\$1.49**

FEDERAL MINING CLAIM CORNER MONUMENT

CLAIM NAME _____
 CLAIMANT _____
 ADDRESS _____
 CORNER NUMBER _____
 DIRECTION TO CORNER POST NO. _____
 DISTANCE TO CORNER POST NO. _____

The NO Prospecting Sign is 11 inches wide and 7 1/2 inches tall and makes it obvious that this is an active mining claim and that no prospecting is allowed.

#-5867 **\$4.95**



Modern Prospecting: How to Find, Claim And Sell Mineral Deposits

To have a better chance of discovering a deposit, a prospector must also recognize the signpost of a favorable area, do the land status research, and follow through with a valid claim staking, soil and rock sampling, and assaying. Roger McPherson , 6x9 soft cover with 303 pages.

#-5227 **\$14.95**



STAKE YOUR CLAIM! A step-by-step guide to owning a gold mine.

The new revised edition tells you everything you need to know to research, locate, and file your own placer or lode mining claim. Detailed step-by-step instructions walk you through the entire process. Forms are included.

#-6276 **\$19.95**



How to Stake and File Your Own Mining Claim DVD

There's nothing quite like owning your own mining claim. Be it gold, sapphires, turquoise, opal, topaz or what every else strikes your fancy. Its not hard to do, in fact it's quit simple and I'll show you exactly how. You as an American citizen have this right as did our pioneer forefathers. We still operate under the 1872 mining law as they did. I'll show you how to use the BLM Legacy Rehost System (LR2000) from your computer at home, to find out if ground is open to staking or location, its not really called staking its called locating.

#-8155 **\$11.95**



GOLD BUDDY DRYWASHERS

Features:

Hoppers & Recovery Boxes: They all have aluminum hoppers and recovery boxes that are precision crafted from aircraft grade aluminum.

Grizzly, Legs and Riffles: The grizzly, legs, and riffles are made of zinc plated steel for years of durable rust free service.

Folding Leg System: Gold Buddy drywashers all feature newly redesigned folding leg systems. The legs are plated steel thin wall square tubing and are shipped attached to the drywasher.

Blowers & Hoses: The three smaller drywashers come with a 3 inch air hose stock, #-5128. They will run on any quality 3 inch, 2 cycle leaf blower available from any lawn & garden store for \$70 to \$130. The Stallion comes complete with the JOBE Hurricane 4 inch blower and a 4 inch air hose.

New for 2012:

(1) Newly designed leg system. The drywashers are manufactured with the legs attached with a base plate that easily attaches to the legs

(2) New one piece recovery tray is completely removable for easy cleanup.

(3) Electrically isolated recovery box: The newly designed recovery box is completely electrically isolated so that the static charge builds quicker, stronger, and does not dissipate quickly.

(4) New Uni-Bearing shaker assembly with steel fan blades. A simple one bearing shaker system is very effective. A metal dust cover keeps dust out of the sealed bearing for years of maintenance free service. The steel fan blades are guaranteed to never need replacement.



(5) Air supply hoses are included.

(7) Working The Drywasher instructional DVD is included with every Gold Buddy Drywasher.

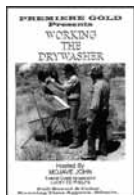

(8) 5 year limited warranty for defects in workmanship. Does not cover normal wear. See warranty for details.

**5 YEAR
LIMITED
WARRANTY**

GOLD BUDDY

**Four Models
Made in the USA**

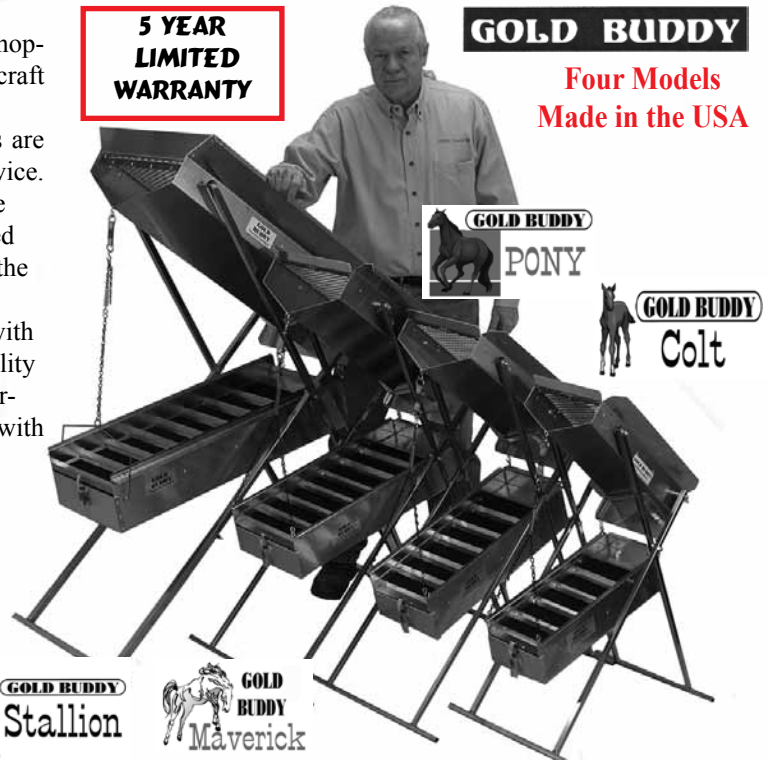

**GOLD BUDDY
Stallion**



**GOLD BUDDY
Maverick**



**GOLD BUDDY
Pony**



**GOLD BUDDY
Colt**

GOLD BUDDY Drywashers are warranted for 5 years for defects in workmanship from the date of purchase. This warranty is to the original owner and includes everything except bearings, and the cloth in the recovery box.

A proven performer through the years, these Gold Buddy drywashers are made in California by JOBE Tools, and are designed to deliver years of service. They have been redesigned for 2012 so that their legendary performance just got even better.

The Gold Buddy VIBRA-LITE COLT:

This is the smallest of the Gold Buddy drywasher family. It is 33" tall and the recovery box is 18" long and 6 1/2" wide. Weighs only 11 pounds. Great for those who need a small testing drywasher or have limited space.

#-5729

\$389.00

The Gold Buddy VIBRA-LITE PONY. Just slightly smaller than the Gold Buddy Maverick standing 38 inches tall. It is our best selling drywasher. The recovery box is 21" long and 9" wide and the complete drywasher weighs only 15 pounds.

#-5728

\$469.00

The Gold Buddy VIBRA-LITE Maverick The original Gold Buddy drywasher this unit stands 43" tall. The recovery box is 24" x 10" and the unit weighs approximately 27 pounds.

#-5727

\$539.00





GOLD BUDDY

Stallion

**THE LARGEST CAPACITY
DRYWASHER
MANUFACTURED IN THE
USA**

The drywasher that has everything. Recover gold in the desert, dry river beds or any gold bearing area. GOLD BUDDY Drywashers recover gold using three processes at the same time. Electrostatic concentration occurs because the high-velocity air flowing through the unit creates an electrical charge which attracts and holds gold. The same airflow holds the material in suspension allowing the heavier materials to sink under the riffles where it is caught. The Uni-Bearing oscillating vibrator shakes the material at the same time further helping the values to sink. The hopper and recovery box are made of aircraft grade aluminum, and the hopper has an adjustable flow gate to meter the material evenly. The recovery box has a removable riffle tray for easy cleanup.

See Blower Details Below

- Hopper 35 1/2 x 21 1/2 inches
- Recovery box 32 x 13
- Total weight 39 lbs
- Stands 54 inches tall
- Includes JOBE Hurricane 4" Blower
- Complete with 10 foot 4" Drywasher Hose
- #-5726

\$1595.00



Blower & Hose are included!



**5 YEAR
LIMITED
WARRANTY**

HURRICANE

- JOBE Hurricane Blower
- Honda GCV 160 cc
- Air Cooled, 4 Stroke, OHC Engine
- 2 year HONDA Warranty on the Engine
- 5 Year Warranty on the Housing and Impeller
- 4 inch Discharge
- All Aluminum Body and Impeller
- weighs 45 lbs
- #-5720

\$599.95

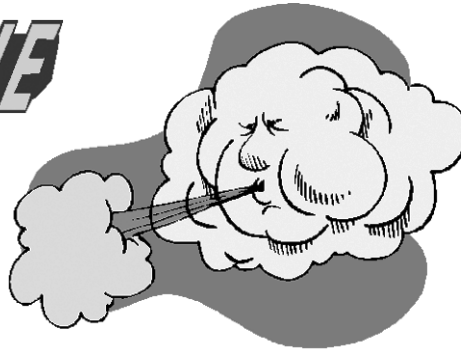

**5 YEAR
LIMITED
WARRANTY**



KEENE BELLOWS-TYPE DRYWASHER

Made of sturdy black Marlex plastic with a steel frame, this little puffer has a proven track record of performance. The oversized Marlex hopper is equipped with an adjustable flow control gate. The vibrating cam shaft and bellows help recover even the finest gold. The unit stands 42" high, and the removable recovery tray is 8-1/2" x 20". The hand crank version weighs only 32 pounds. The 12 volt conversion kit adds 8 pounds.

HAND CRANK DRYWASHER # -K-DW2 \$599.00

WITH 12 VOLT KIT INCLUDED # -K-DW212V \$775.00



KEENE 12 VOLT KIT:

If you have the hand crank dry washer you can purchase the kit to convert it to a 12 volt model. This kit includes everything you need.
#-K-DW12C \$199.00



New for 2012 GOLD BUDDY DRYWASHER COUNTERWEIGHT FAN ASSEMBLIES

These drywasher fans are designed for years of rugged service with sealed no-maintenance bearings. The counter weights are adjustable. We have two sizes. A 4 inch fan unit for small to medium drywashers, like the smaller Gold Buddy or Keene 140 drywashers. A 5 inch unit is available for large drywashers like the large Gold Buddy and the Keene 151.

- #-6080 Small fan assembly w/4" fan **\$49.95**
- #-6081 Large fan assembly w/5" fan **\$54.95**

FAN BLADE ONLY

- Steel replacement fan blade for the small unit, 4 inch fan with 1/4" shaft. #-5166 **\$9.95**
- Steel replacement fan blade for the large unit, 5 inch fan with 1/4" shaft. #-5167 **\$9.95**

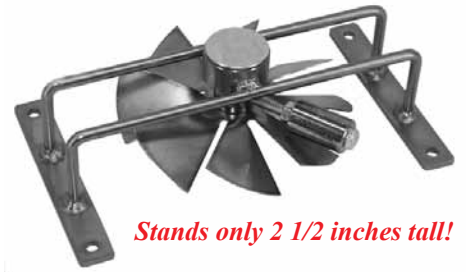

Stands only 2 1/2 inches tall!

DRYWASHER AIR HOSE

Highly durable, lightweight black plastic hose for your drywasher. Specially manufactured for us to have as little resistance as possible because of its smooth bore. Comes in 10' lengths with smooth collars on each end to allow easy hookups. Protected from UV damage.

- #-5128 **(3" hose) \$15.95**
- #-5129 **(4" hose) \$29.95**



SAM RADDING'S BOOKS OF PLANS: This two volume set of plans are easy to understand custom designed plans for the construction of lightweight recreational gold mining equipment.

SAM RADDING'S VOLUME I #-5204 **\$14.95**
Includes plans for a bellows drywasher with plans for a port-a-sluice, rocker box, small rocker, wooden concentrator, rocker concentrator, and a conveyer belt to move material away from your drywasher.

SAM RADDING'S VOLUME II #-5490 **\$14.95**
Includes plans for a vibrostatic drywasher, mini-magic puffer drywasher, several sniping tools and classifier screens.



FINDING GOLD IN THE DESERT

The Art Of Drywashing Updated edition with expert help on how to successfully use a drywasher. Includes plans for building a puffer-type drywasher. 25 pages.

#-5236 **\$5.95**

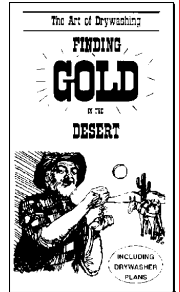

WORKING THE DRYWASHER (DVD)

The best video ever produced for the prospector who owns a drywasher but is not experienced in using it, or the guy who is considering purchasing a drywasher. Hosted by Mojave John, this video is professionally done and covers all the basics of drywashing. In two parts you first go through the science of drywasher design, setup and options. Then it is off to the desert to use two different drywashers in the field. A small sniping-type drywasher, testing areas for gold and then a larger production drywasher. Running time 60 minutes, in color.

DVD \$19.95

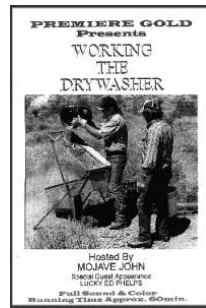

DRY WASHING FOR GOLD

Updated edition with more on modern electronic prospecting and current equipment. Describes dry washing, a profitable means of extracting gold in regions where water sources are not available. Illustrated. Klein, 89 pages. #-5383 **\$9.95**



Economy Drywashing Dust Mask

Contains 5 economy dust masks to help protect your lungs from fine dust particles that get into the air in the process of drywashing.

#-6830 **\$1.49**



FOLLOW THE DRYWASHERS VOL 3

The new 6th edition of Jim Straight's classic "THE NUGGET SHOOTERS BIBLE". How to, where to, techniques, maps, etc. This book was out of print for a few years but now has been republished by popular demand. 265 pages.

#-5233 **\$27.95**



24K Techniques for Arizona Desert Gold Prospecting DVD: Detect, Drywash, and Vacuum for GOLD! Legendary prospectors "NuggetBrain" Wayne and "Panner" Paul adventure for gold while they give tips and show some of the best methods to recover desert gold.

- #-8101 **\$11.95**
- Drywashing: A Complete Guide Part 1 DVD**
- #-8123 **\$11.95**
- Drywashing: A Complete Guide Part 2 DVD**
- #-8124 **\$11.95**



These are all full length professionally created DVDs on drywashing.

GAS VACUUMS and ACCESSORIES

JOBE Tools Gold Ore Six Gallon Super Vac

The JOBE Gold Ore Super Vac is still the most powerful gas powered vacuum designed for gold prospecting and has been upgraded to a six gallon capacity for 2012. This little workhorse sports the new Echo PB251 gas blower with a 25.4 cc two-cycle engine that delivers about 30% more suction than some other gas vacuums on the market. The engine also has a 5 year factory warranty from Echo and is extremely quiet with a catalytic converter. The vacuum comes complete with a 6 foot long 2 1/2 inch vacuum hose, a gold grabbing vacuum crevice tool, and two-cycle oil for the engine. The entire package weighs only 15 pounds. The 6 gallon collection bucket is easy to open with a screw on lid. The discharge of the blower can be used to power a drywasher and comes complete with a quick disconnect to allow quick attachment of the drywasher hose.



#-5581 **\$399.95**



**Echo PB251
Blower**

**5 Year
Warranty**

BUILD YOUR OWN GAS POWERED VACUUM FROM OUR VAC PARTS

We sell everything you need to convert an ordinary 5 gallon bucket and a gas powered leaf blower into a gas powered vacuum. You need our plastic vacuum adapter, the 6 foot 2 1/2" vacuum hose and the vacuum crevice tool. All you need is to attach your 2 cycle blower to the bucket lid to have a gas vac.

VACUUM HOSE

6 feet of 2-1/2" vacuum hose.

#-5793 **\$13.95**

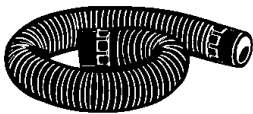

PLASTIC VACUUM ADAPTER

Use this handy fitting to build your own gas vacuum from any 5 gallon bucket. Comes complete with screws and washers. #-5794

\$8.95



CREVICE TOOL

Plastic crevice tool to help you get into the tight spots. 14" long. #-5792

\$6.95



12 VOLT ACCESSORIES

"Y" ADAPTER

Double your 12 volt access with this handy "Y" adapter. Converts from 12 volt cigarette lighter plug to two cigarette lighter receptacles.

#-5183 **\$5.95**



CIGARETTE LIGHTER PLUG

#-5184 **\$1.98**



CIGARETTE LIGHTER JACK

#-5186 **\$1.98**



15 Foot 12 Volt Extension Cord Kit

Comes complete with a 15 foot piece of wire attached to a male cigarette plug on one end and a female socket on the other. It also has a pair of battery clips. By removing either the plug or socket and attaching the battery clips you can rig the extension cord up to work for your application. #-5188 **\$7.95**

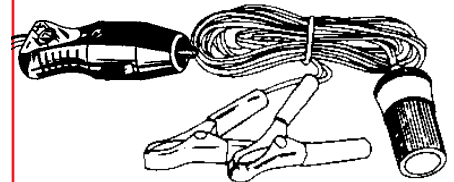

15 Foot Coiled Extension Cord

#-5187

\$6.95



15 Foot Straight Extension Cord

#-5180

\$5.95



BATTERY CLIPS

Pair of battery clips (one red and one black) large enough to grip a full size automobile battery terminal. Approximately 3" in length. #-5182

\$1.98

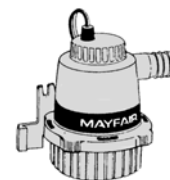

See our selection of 12 Volt Pumps on page 48.

THE GOLD MINER GOLD WHEEL

**5 YEAR
FACTORY
WARRANTY**

SPIRAL GOLD PANNING MACHINE

- BUILT-IN AGITATORS VIBRATE CONCENTRATES TO SETTLE GOLD
- DECREASES PROCESSING TIME 25%
- SELF-CONTAINED CARRYING CASE
- RUNS ALL DAY ON THREE GALLONS OF WATER

The spiral pan is 12 inches in diameter and is made of injection molded plastic for years of reliable service.

Take your Gold Miner spiral panning machine anywhere. The entire weight of the unit is less than 9 lbs including the self-contained carrying case. The dimensions of the carrying case are 20" long, 15 inches wide, and 13" high. The spiral pan is 12 inches in diameter. All components are designed for rugged outdoor use with no lubrication or maintenance. Runs on 12 volts DC.



#-5158 \$324.00

GOLD MINER REPLACEMENT WHEEL



We sell these for you to use to upgrade your existing GOLD MINER or DESERT FOX gold machine to the new GOLD MINER wheel.

#-5621 \$49.00

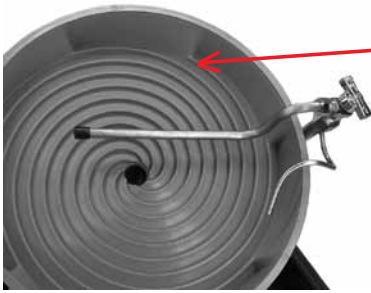

The water volume from the spray bar is adjustable to accurately remove the black sand and leave you with clean gold.

One of the innovative design features is this 1/4 inch drop where each of the seven leads hits the outside of the bowl. The Gold Miner is the only spiral wheel with this gold grabbing feature.



The entire unit stores away neatly into its durable plastic case.

GOLD SCREW *Vibrating Spiral Panner*

Capabilities:

- * Recovers more fine gold - 96-98% of 150 MESH
- * Runs 40 lb of concentrate in an hour
- * Amalgamate concentrates

#-5750

\$995.00

Features :

- * ONE PIECE BOWL with undercut grooves to hold the fine gold in the panner
- * 4 large feeder plows to get material into grooves
- * Jigging/vibration action to settle fine gold into the grooves
- * UV resistant plastic that can withstand 200F without warping to maintain panner's effectiveness with time
- * Stainless steel shaft
- * 12V operation with approximately 3 amp hour draw from unit

GOLD SCREW Automatic Feeder

- * Capacity of 70 lb per hour
- * Makes any spiral work 10 times faster
- * Removes constant trowelling/scooping of concentrates by hand
- * Constant placement of concentrates into the grooves of any panner for better results
- * Can be used on any panner
- * Holds/delivers 20 lb of concentrate which almost equals 20

minutes of scooping cons

#-5751 \$225.00



GOLD GENIE SPIRAL GOLD WHEELS

Gold Genie manufactures three different quality spiral gold wheels. All three are designed to recirculate water with a 12 volt pump which is provided and have the following features.



The **Gold Genie** spiral recovery machines have a quality 18 inch blue spiral pan for easy observation of both gold and black sand. The pan is injection molded from polypropylene plastic. The injection molding under heat and pressure assures an exact copy of the mold with sharp definition of the ridges in the pan which are critical for gold recovery. The deep cut spirals with sharp edges allows the system to work wet or dry.

The controls for both the volume of water from the spray bar and the critical angle of the pan are designed to be easily and accurately adjusted.



The heavy duty 12 volt dc motor has two switchable speeds. The low speed is about 15 rpms and the high speed is about 22 rpms. The switch can be set for high speed, low speed, or off. A separate switch is provided for the 12 volt dc water pump, so the units can operate with or without water. The motor and pump have a total current draw of less than 4 amps.



The gold and other values are collected on the back side of the spiral pan in a high capacity 10 inch gold pan. The fitting in the center of the 18 inch spiral pan, that the gold travels through, is made of high quality stainless steel so that the machines can also be used for amalgamation. The frames are all made from anodized steel for years of rugged service.

**5 YEAR
LIMITED
WARRANTY**

GOLD GENIE SPIRAL GOLD MACHINES are available in three models



The **Miner Model** is designed for high volume applications with adjustable height frame and a plastic skirt which directs all the waste material to the rear.

#-6669



\$699

The **Prospector Model** has a heavy duty fixed-height frame and is the perfect tool for the serious recreational miner or a small commercial operation

#-6667

\$599

Made
In The
USA
By
JOBE



GOLD GENIE 18 inch Replacement Gold Wheel

The key to the GOLD GENIE spiral panner's effectiveness is in its bowl. When you have a Gold Genie you have the only spiral panner with the exclusive patented "Poly G-2 Bowl" with double angle progressive riffles. The "Poly G-2 Bowl" has superior one-piece design - no inserts or seams to trap valuable gold particles. The GOLD GENIE spiral bowl is injection molded for sharp crisp edges that are critical for gold recovery in spiral wheels.

#-6671

\$169.95

GOLD MAGIC®

"Spiral" Gold Recovery System



GOLD MAGIC MODEL 12E



Gold Magic® 12-E

- ✓ Recovers all sizes of gold -- from flour gold to nuggets.
- ✓ Prospect Dry
- ✓ Prospect Wet
- ✓ Fine Gold Recovery from Black Sand
- ✓ Includes 12-volt battery
- ✓ Runs 16 hours on Charge
- ✓ Built-in Charger
- ✓ Instructional DVD
- ✓ Lightweight and portable - weighs just 10 lbs. with battery.

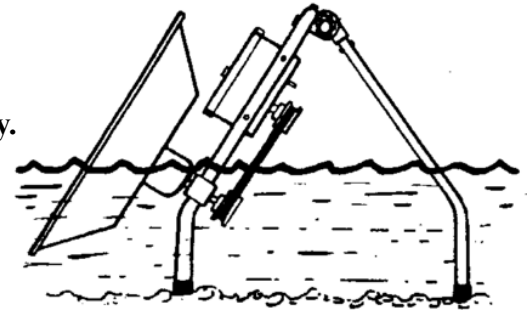

SIDE VIEW IN WATER

1 YEAR WARRANTY

All components are designed for rugged outdoor use. The frame is made of marine-grade aluminum. The fasteners and pan shaft are made of marine-grade stainless steel. No lubrication of any part is needed. We use the latest high tech bearing materials for no maintenance and long life. The motor has a permanently lubricated, sealed gear case. The battery charger is always available because it is built in. The charger will recharge the battery in about 10 hours. There is a built-in control to prevent overcharge. See when you collect gold! The patented removable gold concentration cup allows you to pour your gold directly from the pan into your vial.

#-5744 MODEL 12E **\$419.00**

Powered by a 12 volt motor!

The Gold Magic® Model 10M



Uses the same rugged components as the 12-volt power driven model 12E.

The hand crank has been substituted for the power pack. **Powered by a hand crank!**

#-6180 **\$210.00**

Gold Magic® Model 12-10



All the features of the 12E and the ability for manual operation when desired. Two modes of operation, fully automatic just like the Model 12E and manual operation when needed.

#-6169 **\$455.00**

Powered by a hand crank & 12 volt motor!

THE D.A.M. CONCENTRATOR BOWL

Will quickly recover your fine gold with only the water from a garden hose, or can be rigged to recirculate with a 12 volt pump and a 5 gallon bucket. This is the famous blue plastic bowl designed to work forever with no moving parts. Comes with water flow control valve.

The D.A.M. Bowl is manufactured by Pioneer Mining and is also known as the Blue Bowl. #-6823 **\$74.95**



GOLD CONCENTRATOR BOWL KIT

If you would like to set this unit up to operate it as a 12 volt recirculating system add our 750 gal per hour pump #-5152, 3 feet of 3/4 inch flex hose #-5132 and a pair of battery clips #-5182, See 12 volt section for details. Instructions included. You will also need a five gallon bucket which we do not supply and please note that the optional leg levelers are not included in this kit.

#-5020 D.A.M. Bowl Kit **\$99.95**



Optional Leg Levelers (Set of 3)

Use these 3 plastic adjusters to attach the bowl to the top of a 5 gallon bucket, and perfectly level the bowl by turning the adjustment nuts on each if the 3 levelers.

#-6825 **\$21.95**



GOLD BUDDY MINI HIGHBANKERS

GOLD BUDDY 12 VOLT RECIRCULATING MINI HIGHBANKER

A complete mini-hibanker with many uses - PROSPECTING, SAMPLING, CONCENTRATE CLEANUP. The top classifier box has a classifying section that allows larger stones to drop off the end in a waste pile while the smaller, heavier material is washed into the lower sluice where the gold is trapped in the riffles and carpet. Powered by a 12 volt 750 gph electric pump. The hopper is 7" x 20" and is 4" deep. The sluice is 7 "x 24 inches. The total weight is less than 12 lbs. Comes complete with everything you need except the optional plastic tub, if you want to set it up to recirculate, a plastic tailings bucket, and a 12 volt battery.

#-5690

\$349.00

GOLD BUDDY



Made
In The
USA

GOLD BUDDY V1250 HIGHBANKER

Like the original gold buddy this is a self contained unit with many uses - PROSPECTING, SAMPLING, CONCENTRATE CLEANUP. This is a much higher volume hibanker than the original Gold Buddy, but is designed like the original with a two stage classifier sluice. The upper stage, which contains the classifier screen, is 21 inches long and 8 inches wide. The lower level sluice is 24 inches long, 8 inches wide and 3 3/4 inches tall. It is attached to a sluice stand which has four adjustable legs to conform to any terrain. The unit can be set up to recirculate its own water or in a lake or stream as, a traditional power sluice. It is powered by a 12 volt 1250 gph electric pump which draws only 2.6 amps. The total weight of the V1250 Hibanker is only 14 pounds.

#-5691

\$399.00

GOLD BUDDY

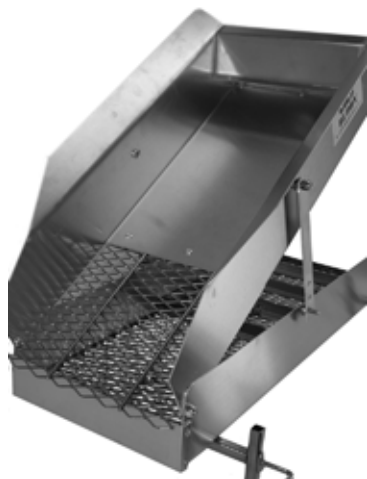

Made
In The
USA

JOBE Stream Sluices & Accessories

JOBE Yellow Jacket Stream Sluices

- ☑ The riffles are designed for superior recovery under different water and gravel conditions. The first few riffles are stream riffles to make it easier for the water to start to move the material, followed by Hungarian riffles to enhance recovery if greater stream volume is available. The body of these sluices are aluminum and the riffles are plated steel.
- ☑ Each sluice includes a section of ribbed black rubber matting for instant gold recognition.
- ☑ A section of diamond cut raised aluminum is included for enhanced fine gold recovery.
- ☑ The riffle latching system is centered for quicker and easier cleanup.
- ☑ The steel riffles are plated for decades of durable service.
- ☑ Accessories are available to convert the 45 inch sluice into a power hibanker or a dredge.
- ☑ The 45 inch sluice has a removable flare.

JOBE 36 Yellow Jacket Stream Sluice
The JOB 36 is 10 inches wide and 36 inches long weighing only 8 pounds.

#-6503 **\$99.95**

JOBE 45 Yellow Jacket Stream Sluice
The JOB 45 is 10 inches wide and 45 inches long weighing only 9 pounds.

#-6504 **\$119.95**



JOB 4 Leg Universal Sluice Stand

This zinc plated steel sluice stand is designed to easily bolt on to any sluice and provide a sturdy platform to use the sluice as a hibanker, power sluice, or dredge. The 1/2 inch square tubular legs are independently adjustable for leveling or setting any angle on any terrain. The legs are 18 inches long. The entire kit weighs about 3 1/2 pounds. All mounting hardware and instructions are included.

#-6501 **\$59.95**



JOB Collapsible Sluice Stand

This zinc plated steel sluice stand is 18 inches wide, 36 inches long and designed to hold any sluice up to 14 inches wide. It provides a sturdy platform to use the sluice as a hibanker, power sluice, or dredge. The 1/2 inch square tubular legs are independently adjustable for leveling or setting any angle on any terrain. The legs are 18 inches long. This is a very large sluice stand when assembled but disassembled it takes up very little space and weighs only 6 pounds.



#-5116 **\$74.95**



JOB Power Sluice Header Box

Converts your stream sluice into a power sluice or hibanker. All precision laser cut aluminum construction. Works on the JOB 45 Yellow Jacket, the Keene A52, or any 10 inch wide sluice. The mounting holes are pre-cut to bolt onto the JOB sluice and the JOB sluice stand. Mounting to the Keene A52 requires two 1/4" holes to be drilled on the sides of the header box. Weighs

only 3 pounds. #-6505 **\$69.95**

JOB Dredge Header Box

The JOB Dredge Header Box is used to convert your stream sluice into a 1 1/2, 2, or 2 1/2 inch dredge. All precision laser cut aluminum construction. Works on the JOB 45 Yellow Jacket, the Keene A52, or any 10 inch wide sluice. Weighs only 5 pounds.

#-6550 1 1/2 inch Header **\$89.95**

#-6551 2 inch Header **\$92.95**

#-6552 2 1/2 inch Header **\$94.95**

The correct dredge adapter is included.

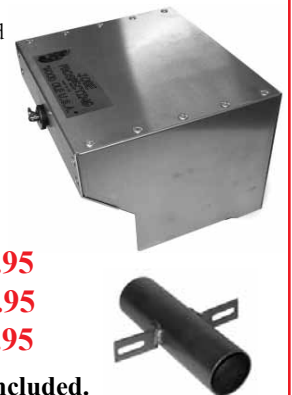

JOBE Hibanker / Dredge Hopper

Use this quality precision laser cut aluminum Hibanker / Dredge Hopper to convert your stream sluice into a Hibanker or Dredge. The top of the hopper is 18 inches x 18 inches with spray bars. The water inlet is equipped with a 1 1/2 inch slip fitting which can be removed to use 1 1/2 inch pipe fittings. The water supply can be adjusted with a valve which is included. Comes ready to go as a hibanker and can be rigged to use as 1 1/2 inch or 2 dredge hopper. Works on the JOBE 45 Yellow Jacket, the Keene A52, or any 10 inch wide sluice. Mounting to the Keene A52 requires two 1/4" holes to be drilled on the sides of the hopper. Total weight is just 15 pounds.

The removable classifier screen is a gold zinc plated steel.



#-6508

\$279.95

GOLD BUDDY Mini Sluices

The lightest, most portable aluminum sluice available. Great for backpacking. The GOLD BUDDY Mini Sluices all have a revolutionary riffle system that is precision laser cut from a single sheet of steel, and then zinc plated. This produces a very lightweight but strong riffle system and the zinc plating allows for decades of rust free service. The sluice body is approximately 24 inches long, 7 inches wide and 2 1/2 inches deep. The unique riffle system is 15 inches long with 5 riffles. At the intake of the sluice you have a section of ribbed vinyl mat followed by the riffles over gold grabbing expanded aluminum and carpet. Available in two models. The Standard Model, #-6524, has a built in flared intake and the Deluxe Model, #-6535, has a detachable flare.

Gold Buddy Mini Sluice

7x24 inches
3.1 Pounds



#-6524

\$74.95

The Gold Buddy Mini Sluice has bent flared intake.

Gold Buddy Deluxe Mini Sluice

7x30 inches
3.8 Pounds



#-6535

\$89.95

The Gold Buddy Deluxe Mini Sluice has a detachable flare.

E-Z Sluices & Accessories

TEE-DEE E-Z SLUICE

The lightest, most portable sluice available. Great for backpacking. Made of polypropylene plastic with 2 ABS plastic Hungarian riffle systems with miners moss pads. The entire unit weighs less than 2 pounds. Custom corrugation molded into the plastic, traps gold making recovery awesome and setup a breeze. The E-Z sluice is black, 2 1/2" deep, 24" long and 7" wide. #-5896 **\$43.95**



E-Z SLUICE KIT

The kit includes the same E-Z sluice as described but adding a few essential goodies for the beginner. Includes a 15 minute DVD on how to use the E-Z sluice and how to pan for gold. A snuffer bottle for picking up the gold from your pan and a 32 page book on how and where to use the E-Z sluice across the USA. #-5897 **\$53.95**

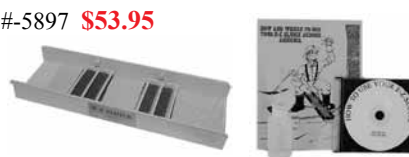

FLARE KIT FOR THE E-Z SLUICE

Aluminum flare and bolts allow you to lengthen the E-Z sluice and enhance its ability to work with low water levels. #-6512 **\$14.95**

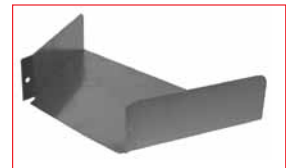

Mini Steel Sluice Stand

This adjustable height sluice frame will work on most small sluices including the GOLD BUDDY Mini Sluice, the E-Z sluice, and the Keene A-51A. The height of each leg is adjustable for a perfect fit to any terrain. Provides a stable platform to use the sluice as a power sluice or a small dredge.



#-6500 **\$64.95**

*Works on the
JOBE MINI SLUICES
TEE-DEE E-Z Sluice
Keene A51A*

JOBE Folding Stream Sluice

#-6506 **\$149.95**



New locking design for 2010:

Only 9 x 14 x 4 when it is folded it is a very small package. Unfolded it is a formidable 9 inch x 50 inch stream sluice that weighs only **7.4 pounds**. This is the perfect sluice for the backpacker or the prospector who has space issues for traveling or storage, but wants the increased production of a larger sluice. Complete with 3 folding sections, expanded aluminum under all the riffles, a detachable flare, and a section of Deep-V vinyl mat.

The sluice body is now designed to lock rigidly in place when the sluice is unfolded. This is as easy as tightening two locking thumb screws.

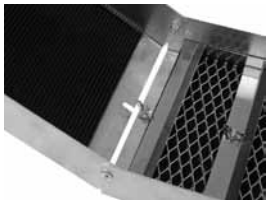

Back Pack For The JOBE Folding Sluice.

This sturdy canvas back pack is perfect for carrying your folding sluice and the other goodies you always need. The large main chamber is 17 inches high, 13 inches wide, and 6 inches deep. It will easily hold the folding sluice, a 10 inch gold pan and other goodies. The pack also has three outside pockets with closures. Made to US Government specifications from extra heavy weight cotton canvas. Double reinforced shoulder straps with black oxide finished hardware.



#-5096

\$34.95

Detachable Shoulder Strap:

The carry strap is removable and extends to 45 inches so that it can be used as a hand or shoulder strap. This allows the carry strap to be easily removed when the sluice is in action.



New Riffle Design:

The riffles are now a Uni-Body construction precision laser cut from a single piece of 18 gauge steel and then formed into ultra light, sturdy steel riffles.

These are then zinc plated for long rust-free service. This innovation cuts about one pound off the weight of the complete sluice.



Stand for Folding Sluice



**Made In
the USA**

Zinc plated steel frame keeps a folding sluice stable and is adjustable to any angle. Disassembled it takes up very little space for backpacking and weighs only 7 pounds.

#-5118 **\$89.95**

Le Trap Sluice and Sluice Stand

The " **RIVER ROBBER** " sluice is made of light weight wear-resistant green plastic. 16 inches wide and 48 inches long but weighs only 4 pounds. The riffles are designed with a two-step ramp which allows the sluice to recover fine gold without vibrating or the use of a carpet liner.

#-5106

\$89.95

**Very Easy
Cleanup**

**Made In
the USA**

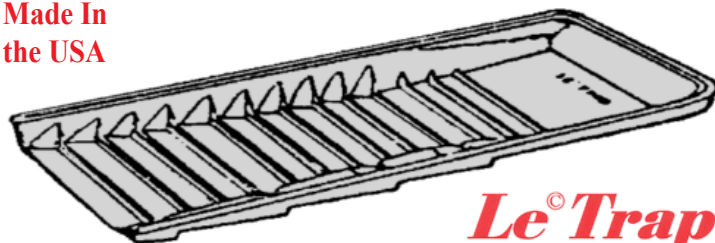

Le Trap

JOBE Collapsible Stand for the Le Trap Sluice

This zinc plated steel sluice stand is 18 inches wide, 36 inches long and designed to hold the Le Trap sluice firmly in place. It provide a sturdy platform to use the sluice as a hibanker, power sluice, or dredge. The 1/2 inch square tubular legs are independently adjustable for leveling or setting any angle on any terrain. The legs are 18 inches long. Disassembled it takes up very little space and weighs only 7 pounds.

Stand for LE Trap Sluice

#-5114

\$89.95

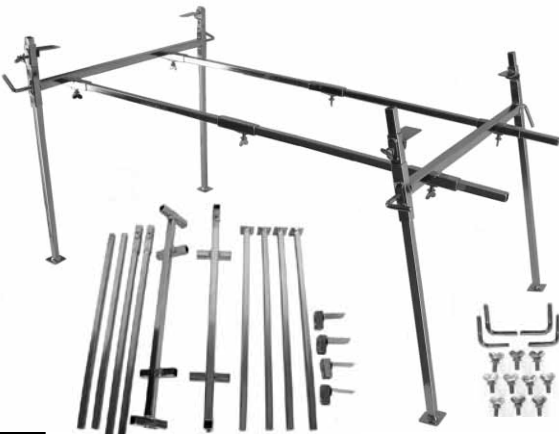

**4 adjustable clamps
hold the sluice firmly
in place.**

JOBE 12 Volt Magnum Power Sluice

The JOBE Magnum Power Sluice is designed around the JOBE 48 inch Yellow Jacket sluice. Attaching the JOBE adjustable 4 leg stand, the JOBE Power Sluice header box, and the Mayfair 2000 gallon-per-hour 12 volt pump all adds up to a very good hi-volume power sluice. It can also be set up with a recovery tub to complete a power sluice recirculating system. Includes 8 feet of 1 1/2 inch discharge hose.

#-6527 **\$374.95**



JOBE 2 1/2 HP Power Sluice

The JOBE Power Sluice is designed around the JOBE 48 inch Yellow Jacket stream sluice. The JOBE adjustable 4 leg stand and the JOBE Power Sluice header box are attached to the sluice. Powered by a JOBE 2 1/2 hp, 4-cycle, gasoline pump. The pump and engine combination weighs only 27 pounds and is mounted on a shock-resistant base plate with a carry handle. It can also be set up with a recovery tub to complete a power sluice recirculating system. Includes 8 feet of 1 1/2 inch intake hose, an intake screen, 25 feet of 1 1/2 inch lay-flat discharge hose, and all necessary fittings. The sluice also comes with an aluminum flare, not shown, which replaces the Power Sluice Header Box so that the sluice can also be used as a normal stream sluice.

#-6528 **\$489.95**

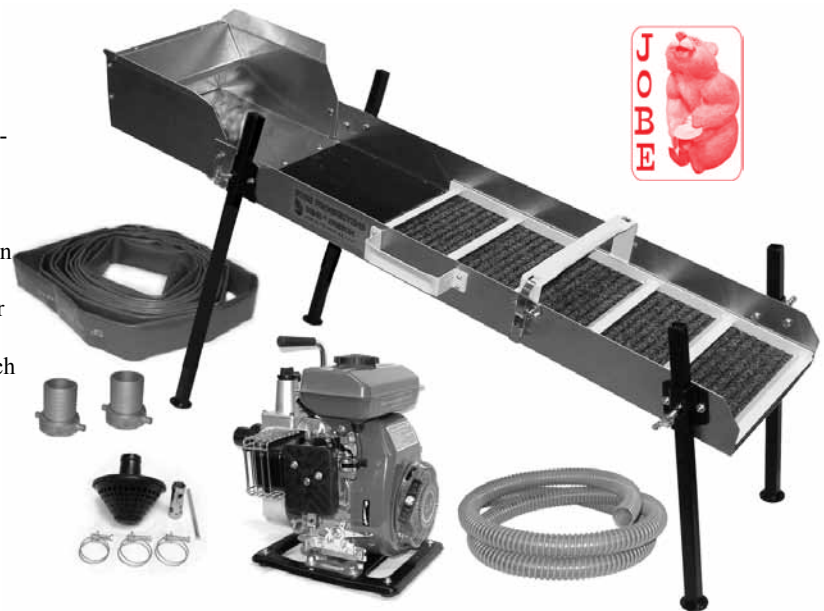

The JOBE Power Sluice / Hibanker

The JOBE Power Sluice is designed around the JOBE 48 inch Yellow Jacket stream sluice. The JOBE adjustable 4 leg stand and the JOBE Hibanker Hopper are attached to the sluice. Powered by a JOBE 2 1/2 hp, 4-cycle, gasoline pump. The pump and engine combination weighs only 27 pounds and is mounted on a shock-resistant base plate with a carry handle. It can also be set up with a recovery tub to complete a hibanker recirculating system. Includes 8 feet of 1 1/2 inch intake hose, an intake screen, 25 feet of 1 1/2 inch lay-flat discharge hose, and all necessary fittings. The sluice also comes with an aluminum flare, not shown, which replaces the Power Sluice Header Box so that the sluice can also be used as a normal stream sluice.

#-6529 **\$699.95**

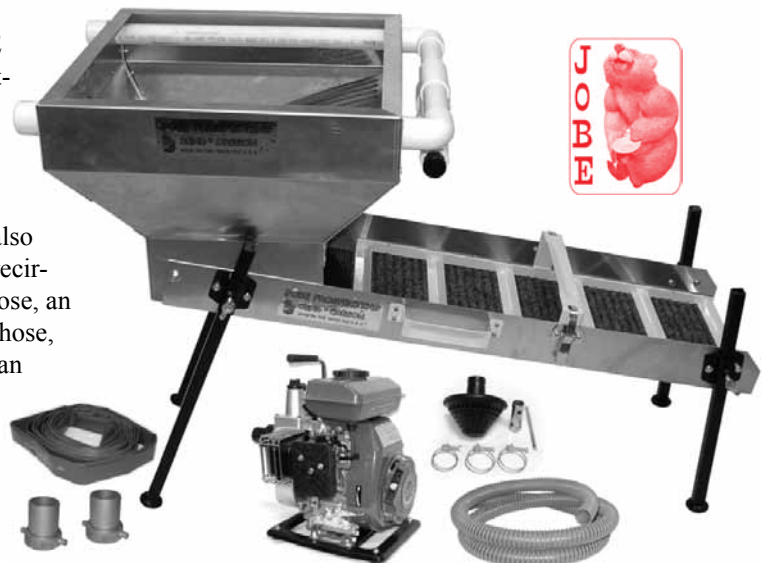

JOBE 1.5 inch SuctionDredge

The JOBE 1 1/2 inch dredge is designed around the JOBE 48 inch Yellow Jacket stream sluice. The JOBE adjustable 4 leg stand and the JOBE Dredge Header Box are attached to the sluice. Powered by a 2.5 horse power, 4-cycle, gasoline pump. The pump and engine combination weighs only 27 pounds and is mounted on a shock-resistant base plate. This unit comes complete with everything you need for a 1.5 inch dredge including all the parts, hoses and clamps. The sluice also comes with an aluminum flare, not shown, which replaces the Dredge Header Box so that the sluice can also be used as a normal stream sluice.

#- 6523 **\$699.95**



JOBE 2 inch SuctionDredge

The JOBE 2 inch dredge is designed around the JOBE 48 inch Yellow Jacket stream sluice. The JOBE adjustable 4 leg stand and the JOBE Dredge Header Box are attached to the sluice. Powered by a Power Lift 6.5 horse power, 4-cycle, gasoline pump. The pump and engine combination weighs only 54 pounds and is mounted on a shock-resistant base plate inside a roll cage. This unit comes complete with everything you need for a 2 inch dredge including all the parts, hoses and clamps. The sluice also comes with an aluminum flare, not shown, which replaces the Dredge Header Box so that the sluice can also be used as a normal stream sluice.

#-6522 **\$769.95**



JOBE 2 inch Suction Dredge/ Hibanker Combo

The JOBE Power Sluice and 2 inch dredge combo is designed around the JOBE 48 inch Yellow Jacket stream sluice. The JOBE adjustable 4 leg stand and the JOBE Hibanker Hopper are attached to the sluice. Powered by a Power Lift 6.5 horse power, 4-cycle, gasoline pump. The pump and engine combination weighs only 54 pounds and is mounted on a shock-resistant base plate inside a roll cage. This unit comes complete with everything you need to use it as either a hibanker or as a 2 inch dredge including all the parts, hoses and clamps. The sluice also comes with an aluminum flare, not shown, which replaces the Power Sluice Header Box so that the sluice can also be used as a normal stream sluice.



GOLD BUDDY

FLOATING DREDGES

All new for 2012:

Available with 2 inch suction nozzle model and in 2 1/2 inch models with either a suction nozzle or power jet arrangement.

All feature:

Honda power coupled to a JOBE 95 GPM high pressure aluminum pump.

The revolutionary GOLD BUDDY 10 x 17 **GOLD WEDGE SLUICE**. The average total weight of the complete dredge is 65 pounds varying slightly configuration.

GOLD BUDDY Uni-Float one piece flotation system.

- #-7551 2 inch suction nozzle \$1595
- #-7552 2 1/2 inch suction nozzle \$1695
- #-7550 2 1/2 inch OS Power Jet \$1695



Features



Back-Pack Dredge Flotation: The polypropylene flotation platform is 27 x 41 inches and weighs 15 pounds. The unique combined design of our Back-Pack dredges frame and flotation makes for a very lightweight but rugged support system. Works on all our Back-Pack dredges, power jet and suction nozzle plus a variety of dredges and hibankers manufactured by JOBE, Keene, and proline. About anything with a 10 inch sluice can be adapted to work with this flotation



The Gold Wedge Flared Aluminum Sluice: The 40 inch long sluice is designed as a natural gold trap starting 10 inches wide and flared to 17 inches wide. As the sluice widens the water velocity slows and drops values. Complete with .085 diamond cut expanded aluminum over carpet, zinc plated steel riffles, and a classifier screen to enhance fine gold recovery. The input end is 10 inches wide and designed to work with a number of JOBE sluice accessories. Weighs just a little over 13 pounds.



Oversize Jet Flare: The JOBE oversize jet flare is 10 inches wide and 24 inches long. Weighs just 3 pounds. Works with the 2 1/2 power jet dredges and is designed to be compatible with about any 10 inch wide sluice including the JOBE 6504 Yellow Jacket and the Keene A52 sluices.



The 2 1/2 inch power jet model uses a two piece Oversize 2 1/2 inch Power Jet: The JOBE oversize 2 1/2 inch power jet is 15 inches long and weighs 3 pounds. The 2 1/2 inch suction hose fits inside the power jet to reduce the possibility of jams.



Honda 2.5 HP Engine / Pump: A proven workhorse combination is the 2 1/2 HP Honda Engine coupled to the JOBE 90 GPM pump. The engine /pump is mounted to plated steel base plate with shock absorbent feet in case you want to use the pump in a free standing application off the dredge. This base plate is attached to a plated steel frame for use on the dredge. The motor pump-frame assembly detaches completely from the dredge with 2 thumb screws for quick

assembly/disassembly or for on-the-bank fueling. The motor/pump with the base plate weighs 18 pounds and frame adds only 2.8 pounds.

For the 2 inch suction nozzle configuration we use the JOBE Dredge header box in place of the Jet Flare and the JOBE 2 inch suction nozzle instead of the power jet tube..



KEENE 3 INCH ULTRA MINI DREDGE

The Ultra 3 has set a new standard for smaller sized dredges. The unmatched performance of this dredge system is designed for those who operate in extremely remote and challenging locations. It can be easily transported and is lightweight and quick to assemble. Powered by a variety of engines, pumps and compressors offering a choice of power to fit individual needs. The Ultra 3 features our high performance 3 inch sluice box recovery system with a longer expanded metal classification screen, black ribbed rubber for quick recognition of values and miner moss for excellent gold retention. Comes with a shorter oversized power jet and longer Marlex Jet Flare for greater suction power and non clogging features. The one piece ribbed lightweight Marlex floats and two piece frame provide a compact package that when assembled is smaller lighter and more compact than all previous three inch dredge models.



#K-3400PH 3" Ultra Mini w/ Honda 4 hp weighs 159 pounds **\$2395** (Keene Model 3400PH)
 #K-3405PH 3" Ultra Mini w/ Honda 4 hp & T80 Compressor weighs 169 pounds **\$2775** (Keene Model 3405PH)

KEENE 4 INCH DREDGES

Keene's new 4" dredge is ideal for the prospector requiring a light portable dredge with capacity to move large amounts of material. Experience the professional recovery features of larger dredges.

New Features:

New 3 stage sluice box for unsurpassed fine gold recovery. The best in the business. !!!

New improved P180 pump has proven to be the highest performing pump on the market.

New improved 4" floats with built in tool boxes and drink holders with bottom runners for rocky rivers and fast water.

New improved float frame with new handle inserts, ideal for picking up and carrying dredge through fast water conditions.

New adjustable jet flare can be raised and positioned at frame level for transporting through rapids and shallow areas.



#K-4500P 4" Dredge w/ Brigs 6.5 hp weighs 173 pounds **\$3039** (Keene Model 4500P)
 #K-4500PH 4" Dredge w/ Honda 6.5 hp weighs 175 pounds **\$3175** (Keene Model 4500PH)
 #K-4505P 4" Dredge w/ Brigs 6.5 hp & T80 Compressor weighs 185 pounds **\$3450** (Keene Model 4505P)
 #K-4505PH 4" Dredge w/ Honda 6.5 hp & T80 Compressor weighs 188 pounds **\$3595** (Keene Model 4505PH)

SLUICE ACCESSORIES

RIBBED LOW PROFILE VINYL MAT

Black ribbed vinyl matting added to your sluice gives instant recognition to see the presence of gold without needing to clean the sluice. This product is also used in "poop tubes" and other cleanup appliances. The overall height of the mat is 60/1000th of an inch and the depth of the groove is 30/1000th of an inch.

#-5732 12x24 **\$10.95**
 #-5733 18x24 **\$12.95**
 #-5734 24x24 **\$16.95**



Low Profile mat side view

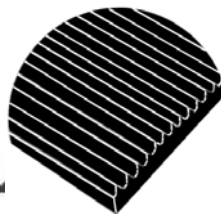

TUFF-STUFF DEEP V GROOVED MAT

Rugged but lightweight this product is specially made for us to provide a deep vee rubberized mat tough enough to stand up to the rigors of prospecting but thin enough to not require special applications. The overall height of the mat is 150/1000th of an inch and the depth of the groove is 110/1000th of an inch.

#-5742 12" x 24" **\$10.95**
 #-5741 12" x 48" **\$16.95**
 #-5743 18" x 48" **\$23.95**
 #-5731 24" x 48" **\$27.95**



Tuff-Stuff mat side view

MINERS MOSS

Nomad matting is the same ultimate matting for gold recovery in any sluicing or dredging situation. Traps and holds gold inside woven vinyl fibers. Preferred by commercial dredgers.

#-5083 12"x36" **\$34.95**
 #-6771 18"x36" **\$51.95**
 #-6773 18"x48" **\$68.95**
 #-6772 24"x36" **\$68.95**
 #-6774 36"x60" **\$172.95**



CLAY-GONE: CAUSES CLAY AND SUSPENDED MATERIALS TO DROP FROM WATER IN SECONDS

For use in panning tubs, jigs, gold wheels, recirculating systems and more. This product is a must for stretching the usability of water. Is compatible with soaps and other surface tension breaking additives. Use 1 tablespoon of product per 10 gallons of water. Bottle contains 8 ounces. Highly concentrated.

#-5980 **\$8.95**



JOBE 6.5 HP High Pressure Pump

This is a real workhorse to run a 3 or 4 inch dredge or a large highbanker dredge combo. The pump is made in the USA and the engine is made in China. 90 day warranty. Assembled in the USA.

- 6.5 horse power
- Inlet 2 inch slip
- Outlet 1.5 inch mpt
- 240 gallons per minute
- Maximum head 155 feet
- All aluminum pump
- 4 stroke OHV air cooled
- Low Oil Shut off

#-7512 **\$599**



JOBE High Pressure Centrifugal Pumps

Aluminum castings with steel slip intake and steel threaded discharge.

- #-7514 1.5 x 1.25 95GPM **\$229.95**
- #-7515 2 x 1.5 240 GPM **\$339.95**



JOBE 6.5 HP Semi-Trash Pump

Inlet / outlet 2 inch, Maximum head 92 feet, Maximum suction head 26 feet, 4 stroke OHV forced air cooled, Steel roll cage, Isolation mounts, 1 gallon fuel tank, Recoil start, Sound rating 70db@ 20 feet, Weighs 54 pounds

- Isolation mounts
- 1 gallon fuel tank
- Recoil start
- Low oil shut off
- Weighs 44 pounds

#-6526

\$299.95

Made in China. 90 day warranty.



JOBE 2 1/2 HP Water Pump

This quality lightweight water pump is powered by a 2 1/2 horse power, 4 cycle gasoline engine. The pump and engine combination weighs only 27 pounds and is mounted on a shock-resistant base plate with a carry handle. The intake and discharge are both 1 1/2 inch with a maximum discharge of 3170 gph (52.8 gpm). The suction head is 13 feet and the discharge head is 82 feet. 90 Day warranty.

Not Available in California. Made in China. #-6525 **\$249.95**

12 Volt Pumps

Mayfair 2200 GPH 12 Volt PUMP

Can be set up with either a 1-1/8" or 1-1/2" discharge. Rigged with the smaller discharge, it delivers 1800 gph. With the 1-1/2" discharge it has a 2200 GPH output. Draws 7amps @12 vdc. Submersible.

#-5150 **\$99.95**

MAYFAIR 12 VOLT PUMPS

Mayfair PRO-LINE 12 volt submersible

pumps have powerful permanent magnet motors and 3/4" discharge. These little workhorses are the standard pumps used on gold wheels, mini-sluices and

recirculating systems. Made in USA. 18 month warranty. 500 gph unit draws 2 amps; 750 gph draws 2.6 amps; 1000 gph draws 4.5 amps.



| CATALOG | GALLONS PER HOUR | PRICE |
|---------|------------------|----------------|
| #-5153 | 500 GPH | \$19.95 |
| #-5152 | 750 GPH | \$32.95 |
| #-5151 | 1000 GPH | \$39.95 |
| #-5149 | 1250 GPH | \$49.95 |

Note: #-5149 has 1 1/8" discharge

Hydraulic Flusher

Attaches to a garden hose and is used to clean crevices using the garden hose outlet on your dredge pump. Comes on when the black section of tubing is bent and shuts off when the bend is released.

#-5969

\$24.95

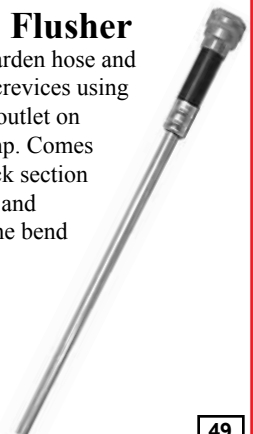



HOSE FOR DREDGING

"Clearflow" suction hose is perfect for dredge suction and low pressure applications. Smooth interior bore helps prevent clogs and does not hinder the movement of material. Clear valleys between the ribs allow the operator to see the material or water moving through the hose. Made to withstand temperature changes and to prevent damage due to sunlight. Very flexible and light weight.

| CATALOG | SIZE | COST PER FOOT |
|---------|--------|---------------|
| #-5134 | 1-1/2" | \$3.50 |
| #-5135 | 2" | \$3.95 |
| #-5136 | 2-1/2" | \$4.95 |
| #-5927 | 3" | \$6.00 |
| #-5928 | 4" | \$9.95 |

Clearflow Pressure Hose

"See through" pressure hose for use on suction dredges.



| | | |
|--------|------------|------------------|
| #-5943 | 1 1/4 inch | \$ 2.95 per foot |
| #-5944 | 1 1/2 inch | \$ 3.49 per foot |
| #-5945 | 2 inch | \$ 4.49 per foot |



Lay Flat Discharge Hose

Made of flexible PVC and folds flat for easy storage. Best used in applications that do not require a lot of movement of the hose.

| | | |
|--------|------------|-----------------|
| #-5775 | 1 1/4 inch | \$1.35 per foot |
| #-5776 | 1 1/2 inch | \$1.75 per foot |
| #-5131 | 2 inch | \$2.09 per foot |



FLEXIBLE HOSE

Use this hose for the above pumps. Very light and very flexible - just the ticket for your project. This hose is ribbed, but has collars every 12 inches. Cut to any length you need from 12 inches to 25 feet.

| | | |
|--------|------------|------------------------|
| #-5132 | 3/4 inch | \$9.50 per foot |
| #-5133 | 1 1/8 inch | \$1.25 per foot |

KEENE FOOT VALVES WITH STRAINERS

Foot valves contain rubber flap-pers which allow water to only go into the pump and not out. A must for pumps that are not self priming and a time saver for self priming pumps.

| | | |
|---------|--------|----------------|
| #K-FV15 | 1-1/2" | \$40.00 |
| #K-FV2 | 2" | \$42.00 |
| #K-FV25 | 2 1/2" | \$45.00 |



Pin Lug Hose Fittings

Slip hose fitting to female pipe threads with pin lug type head.



| CATALOG # | SIZE | COST |
|-----------|--------|----------------|
| #-5904 | 1 1/2" | \$8.95 |
| #-5905 | 2" | \$10.95 |

This is the male counter part of the female fitting above. Use the pair to couple hoses together.



| CATALOG # | SIZE | COST |
|-----------|--------|---------------|
| #-5907 | 1 1/2" | \$7.95 |
| #-5908 | 2" | \$9.95 |

JOBE Knurled Head Pipe to Hose Adapter

This 1 1/4 adapter is precision machined aluminum with 1 1/4 female pipe threads to 1 1/4 slip. Perfect for attaching 1 1/4 pressure hose to a suction nozzle.

#-5931 **\$13.95**



JOBE Hose Adapters

These adapters are designed to make a smooth transition between the pump discharge and pressure hose. Features a brass nut with female pipe threads with a machined aluminum slip fitting.



| | | |
|--------|-----------------------------|----------------|
| #-5932 | 1 1/2 in pipe to 1 1/4 slip | \$16.95 |
| #-5933 | 2 inch pipe to 1 1/4 slip | \$18.95 |
| #-5934 | 2 inch pipe to 1 1/2 slip | \$18.95 |

JOBE SUCTION NOZZLES

Precision manufactured from thin-wall plated steel tubing with machined orifices to create maximum suction. Ideal for shallow water dredging conditions.



| CAT # | OUTLET SIZE | INLET SIZE | PRICE |
|--------|-------------|------------|-----------------|
| #-7620 | 1 1/2" | 1.25" | \$93.00 |
| #-7621 | 2" | 1.25" | \$99.95 |
| #-7622 | 2 1/2" | 1.25" | \$112.00 |
| #-7623 | 3" | 1.5" | \$145.00 |



JOBE SUCTION Tips

JOBE Suction Tips are made of thin walled plated steel tubing and are available in sizes ranging from 1 1/2 inches to 3 inches. Comes with appropriate stainless steel hose clamp.

| | | |
|--------|------------|----------------|
| #-7710 | 1 1/2 Inch | \$18.95 |
| #-7712 | 2 inch | \$18.95 |
| #-7714 | 2 1/2 inch | \$21.95 |
| #-7716 | 3 inch | \$24.95 |

Stainless Steel Hose Clamps

| | | |
|--------|------------|--------|
| #-6651 | 1 1/4 inch | \$1.50 |
| #-6670 | 1 1/2 inch | \$1.50 |
| #-6662 | 2 inch | \$1.65 |
| #-6661 | 2 1/2 Inch | \$1.95 |



JOBE Dredge Adapters

Designed to attach dredge hoses to dredge header boxes. These adapters are made with thin wall steel tubing to minimize hose blockage and zinc plated for years of maintenance free service.

| | | |
|--------|---------------------------|----------------|
| #-6540 | 1 1/2 inch adapter | \$23.95 |
| #-6541 | 2 inch dredge adapter | \$23.95 |
| #-6542 | 2 1/2 inch dredge adapter | \$24.95 |



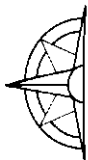

DELORME MAPPING

ATLASES, MAPS & GAZETTEERS

Large Scale ... Full Color ... Unbeatable Detail. Back Roads, Dirt Roads and Trails, Hidden Lakes, Forests, Streams, Swamps, Public Land, Railroads, Airfields, Campgrounds, Campsites and Power Lines. DeLorme Atlas & Gazetteer series covers all 50 states from Florida to Alaska, with the most comprehensive detail available. Each state is shown in its entirety. Delaware and Maryland are combined as are Connecticut and Rhode Island.

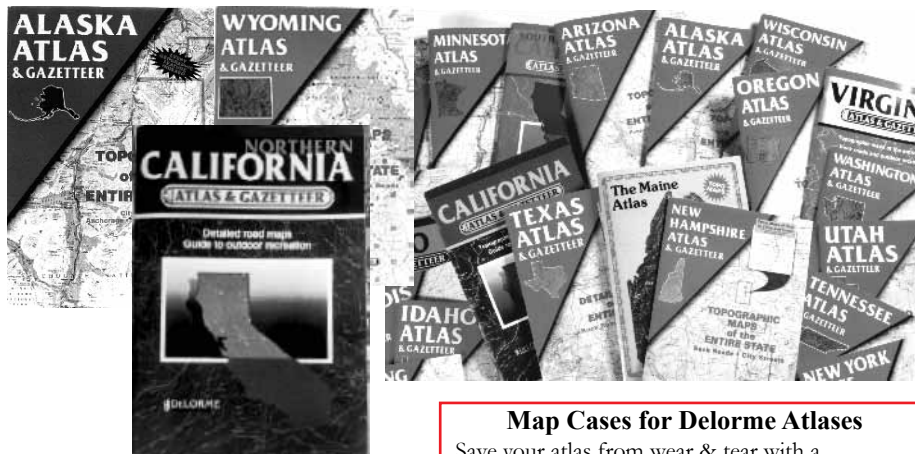

| STATE | CAT. # | PRICE |
|------------------|--------|---------|
| ALABAMA | #5890 | \$19.95 |
| ALASKA | #-5419 | \$19.95 |
| ARIZONA | #-5210 | \$19.95 |
| ARKANSAS | #-5839 | \$19.95 |
| CALIFORNIA | #-6233 | \$24.95 |
| COLORADO | #-5418 | \$19.95 |
| CONN./ RHODE ISL | #-5864 | \$19.95 |
| DELAWARE / MD | #-5846 | \$19.95 |
| FLORIDA | #-5845 | \$19.95 |
| GEORGIA | #-5833 | \$19.95 |
| HAWAII | #-5880 | \$19.95 |
| IDAHO | #-5416 | \$19.95 |
| ILLINOIS | #-5843 | \$19.95 |
| INDIANA | #-6207 | \$19.95 |
| IOWA | #-6208 | \$19.95 |
| KANSAS | #-6232 | \$19.95 |
| KENTUCKY | #-6230 | \$19.95 |
| LOUISIANA | #-5834 | \$19.95 |
| MAINE | #-5842 | \$19.95 |
| MARYLAND / DEL | #-5846 | \$19.95 |
| MASSACHUSETTS | #-6212 | \$19.95 |
| MICHIGAN | #-5848 | \$19.95 |
| MINNESOTA | #-5849 | \$19.95 |
| MISSISSIPPI | #-6238 | \$19.95 |
| MISSOURI | #-5838 | \$19.95 |

| | | |
|-----------------|--------|---------|
| MONTANA | #-5841 | \$19.95 |
| NEBRASKA | #-5859 | \$19.95 |
| NEVADA | #-5858 | \$19.95 |
| NEW HAMPSHIRE | #-5850 | \$19.95 |
| NEW JERSEY | #-5881 | \$19.95 |
| NEW MEXICO | #-5836 | \$19.95 |
| NEW YORK | #-5851 | \$19.95 |
| NORTH CAROLINA | #-5852 | \$19.95 |
| NORTH DAKOTA | #-5882 | \$19.95 |
| OHIO | #-5844 | \$19.95 |
| OKLAHOMA | #-6206 | \$19.95 |
| OREGON | #-5211 | \$19.95 |
| PENNSYLVANIA | #-5853 | \$19.95 |
| RHODE ISL/ CONN | #-5864 | \$19.95 |
| SOUTH CAROLINA | #-5837 | \$19.95 |
| SOUTH DAKOTA | #-6229 | \$19.95 |
| TENNESSEE | #-5854 | \$19.95 |
| TEXAS | #-5847 | \$24.95 |
| UTAH | #-5840 | \$19.95 |
| VERMONT | #-5855 | \$19.95 |
| VIRGINIA | #-5856 | \$19.95 |
| WASHINGTON | #-5420 | \$19.95 |
| WEST VIRGINIA | #-6231 | \$19.95 |
| WISCONSIN | #-5857 | \$19.95 |
| WYOMING | #-5417 | \$19.95 |

Map Cases for Delorme Atlases

Save your atlas from wear & tear with a protective, waterproof, rugged black nylon case. Holds up to 3 atlases plus some folded maps. Made of durable nylon fabric with a zipper closure. Includes a clear plastic panel on one side so you can see the atlas with the case closed.



#-5861 **\$13.95**

Clear Plastic Atlas Covers

Durable clear plastic atlas cover works on any of the above Delorme map books to prolong the life of the atlas by protecting it from damage.

#-5863 **\$3.95**

Cotton Canvas Atlas Case

Durable cotton canvas atlas cover works on any of the Delorme map books to prolong the life of the atlas.

The case is 17 inches x 12 inches with a zipper closure



and a carry strap. #-5860 **\$3.95**

State Ghost Town Sites Then & Now (Map Sets)

Each state is represented by a series of maps showing what the state looked like in the late 1800s with a clear overlay showing modern roads and highways. Great for locating old town sites, early roads, railroads and forts. Each set contains several maps.

| | | |
|--------|-------------------|---------|
| #-4010 | Arizona | \$12.95 |
| #-4018 | California, North | \$12.95 |
| #-4020 | California, South | \$12.95 |
| #-4025 | Colorado | \$12.95 |
| #-4012 | Idaho | \$12.95 |
| #-4027 | Montana | \$12.95 |
| #-4023 | Nevada | \$12.95 |
| #-4030 | New Mexico | \$12.95 |
| #-4014 | Oregon | \$12.95 |
| #-4032 | Utah | \$12.95 |
| #-4016 | Washington | \$12.95 |

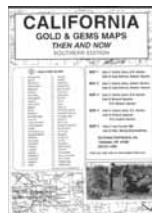

State Gold & Gem Maps Then and Now

(Map Sets) Detailed state maps showing where to find gold and gems. Including old mining district maps. Several maps per set for each state.

| | | |
|--------|-----------------|---------|
| #-4011 | Arizona | \$12.95 |
| #-4019 | California, No. | \$12.95 |
| #-4021 | California, So. | \$12.95 |
| #-4024 | Colorado | \$12.95 |
| #-4013 | Idaho | \$12.95 |
| #-4028 | Montana | \$12.95 |
| #-4022 | Nevada | \$12.95 |
| #-4029 | New Mexico | \$12.95 |
| #-4015 | Oregon | \$12.95 |
| #-4031 | Utah | \$12.95 |
| #-4017 | Washington | \$12.95 |

Stuff for Navigation

MAP MEASURER

Map measurer roller calculates distances by rolling the measurer across the map. Works on any map with an inch-to-mile or cm-to-kilometer scale
#-5747 **\$10.95**



BASIC MAP COMPASS

This inexpensive map compass is the tool you need to locate claims from topo maps. For map orienting work it has a large clear base with straight edge and a magnifying lens. Measuring scale in inches and millimeters. Liquid filled for accuracy and a jewel needle with luminous pointer. Includes carrying lanyard.
#-5818 **\$8.95**

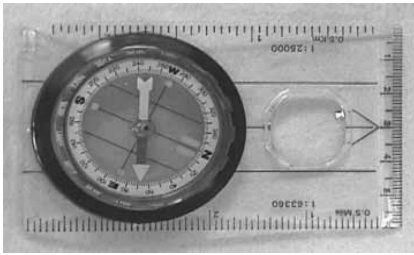

Military Style Sighting Compass

High impact plastic case. Hairline guide wire in lid for precision aiming. Large luminous direction digits and needle for exact aiming.

#-5819 **\$6.95**



Map Scales for USGS & DELORME Maps

The following map scales are used on various topo maps to locate exact latitude and longitude coordinates for any spot on the map. The various scales are outlined below with a description of the USGS and DELORME maps that they will work on. Each of these individual map scales can be used to locate either latitude-longitude or UTM coordinates. They are packaged in a protective plastic case with detailed instructions.

| Scale | Stock# | Will work on these maps. | \$4.95 each |
|-----------|--------|--|--------------------|
| 1:24,000 | #-5985 | USGS 7.5 minute topo maps. | |
| 1:65,000 | #-5986 | Delorme Atlas & Gazetteers for: CT | |
| 1:77,000 | #-5987 | Delorme Atlas & Gazetteers for: NJ | |
| 1:84,000 | #-5988 | Delorme Atlas & Gazetteers for: HI | |
| 1:100,000 | #-5989 | USGS 30x60 minute topo maps. Delorme Atlas & Gazetteers for: DE, MD, NH, VT | |
| 1:125,000 | #-5990 | Delorme Atlas & Gazetteers for: ME | |
| 1:150,000 | #-5991 | Delorme Atlas & Gazetteers for: CA, FL, IL, KY, MI, NY, NC, OH, OK, OR, PA, SC, TN, VA, WA, WV, WI | |
| 1:156,000 | #-5992 | Delorme Atlas & Gazetteers for: IN | |
| 1:160,000 | #-5993 | Delorme Atlas & Gazetteers for: CO | |
| 1:182,000 | #-5994 | Delorme Atlas & Gazetteers for: GA, LA, MS | |
| 1:190,000 | #-5995 | Delorme Atlas & Gazetteers for: MN | |
| 1,200,000 | #-5996 | Delorme Atlas & Gazetteers for: AL, AR, IA, KS, MO, NE, ND, SD | |
| 1:250,000 | #-5997 | USGS 1x2 degree topo maps. Delorme Atlas & Gazetteers for: AZ, ID, MT, NV, UT, WY | |
| 1:300,000 | #-5998 | Delorme Atlas & Gazetteers for: AR, NM | |
| 1:400,000 | #-5999 | Delorme Atlas & Gazetteers for: AK, TX | |

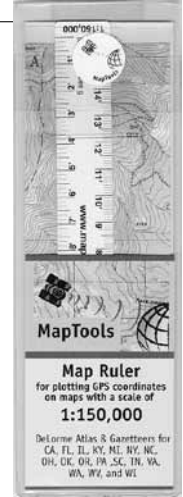

WILDERNESS NAVIGATION: Finding your way using MAP, COMPASS, ALTIMETER, & GPS.

This guide makes getting there and back easy. It embodies the essence of wilderness navigation, thoroughly covered, simply described. Nicely illustrated this dandy guide book covers all the basics of wilderness navigation with sections on all the key tools and techniques, how to read and use maps, easy compass techniques, accurate use of clinometers and altimeters, and practical GPS receiver techniques. Bob and Mike Burns, 126 pages. #6021 **\$12.95**



UTM GRID READER

Transparent, laminated scale used to plot UTM coordinates from your GPS receiver to maps and visa versa. Has the following scales available: 1:24,000, 1:62,500, 1:63,360, 1:25,000, 1:50,000, 1:100,000, 1:150,000, and 1:250,000. Scale also incorporates a full 360 degree protractor. 5" x 6".
#-5984 **\$6.95**

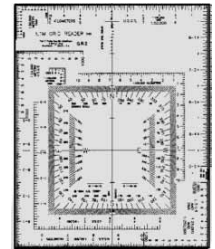

STAYING FOUND

The complete map and compass handbook. Orienting, reading topographic maps, following bearings, magnetic declination, and using nature as a guide. June Fleming, 160 pages.

#-5871 **\$12.95**

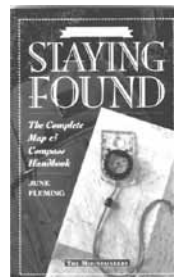

GPS MADE EASY

GPS Made Easy tells you all you need to know about using hand-held GPS receivers as a tool for accurate navigation in the outdoors. It explains how GPS works, describes the features of GPS receivers, and gives practical examples of how to use GPS receivers in a variety of outdoor situations. Lawrence Latham, 112 pages.
#-5870 **\$16.95**



GHOST TOWNS & HISTORIC MINING AREAS

GHOST OF THE GLORY TRAIL

Intimate glimpses into the past and present of 275 western ghost towns. Covers all of Nevada and parts of California and Utah. Murbarger, 316 pages.

#-6247 **\$19.95**

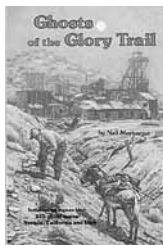

GHOST TOWNS AND HISTORICAL HAUNTS OF ARIZONA

Stories that first appeared in the Arizona Republic and The Phoenix Gazette reveal real life in the old mining towns in words and photos. Heatwole, 144 pages. #-5427 **\$12.95**



GHOST TOWNS AND MINING CAMPS OF CALIFORNIA.

Fourth edition of a classic. Brings to life the turbulent times in the heyday of each town and guides the visitor to the sights that are relics of those times. Historic photos. Nadiou, 324 pages.

#-5357 **\$24.95**

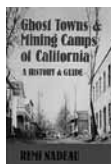

GHOST TOWNS AND MINING CAMPS OF NEW MEXICO

JAMES & BARBARA SHERMAN

#-6186 270 PAGES **\$24.95**



GHOST TOWNS OF ARIZONA

JAMES & BARBARA SHERMAN

#-6184 208 PAGES **\$24.95**

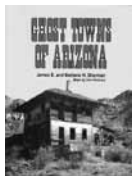

GHOST TOWNS OF TEXAS

T. BAKER, 196 pages.

#-6188 **\$24.95**

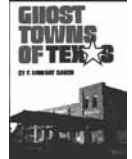

COLORADO GHOST TOWNS & MINING CAMPS

SANDRA DALLAS, 254 pages.

#-6190 **\$24.95**

SOUTHERN CALIFORNIA'S BEST GHOST TOWNS

PHILIP VARNEY, 137 Pages.

#-6183 **\$19.95**



CALIFORNIA GHOST TOWN TRAILS

Best selling guide showing the old ghost towns as they appear today. Detailed maps, interesting facts and historical data. Illustrated. Broman & Leadabrand, 128 pages.

#-5353 **\$7.95**

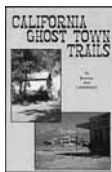

THE MINING CAMPS SPEAK

This book begins where other ghost town and historic site guidebooks end. It is the first book to help you discover what happened and in what time period, Sherlock Homes style, when little or nothing of the site remains. Includes a very nicely illustrated section on the history and identification of tin cans and the remains of mining equipment. Beth and Bill Sagstetter, 8 1/2 x 11 inches, soft cover with 279 pages. #-4057 **\$22.95**



WESTERN ARIZONA GHOST TOWNS

Yuma, Parker and Kingman area mining camps. Directions, histories and photos of over 40 sites. 9" x 12". Paher, 63 pages.

#-6270 **\$9.95**



DEATH VALLEY GHOST TOWNS, VOLUME 1 AND VOLUME 2.

An attractive, oversized guide to the ghost towns of Death Valley. Many photos and detailed history of the old mining camps as they once existed. Illustrated. Paher.

VOLUME 1 #-5355 **\$6.95**

VOLUME 2 #-5356 **\$6.95**

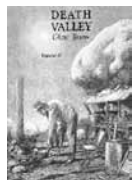

State Ghost Town Sites Then & Now (Map Sets)

Each state is represented by a series of maps showing what the state looked like in the late 1800s with a clear overlay showing modern roads and highways. Great for locating old town sites, early roads, railroads and forts. Each set contains several maps.

| | | |
|--------|-------------------|----------------|
| #-4010 | Arizona | \$12.95 |
| #-4018 | California, North | \$12.95 |
| #-4020 | California, South | \$12.95 |
| #-4025 | Colorado | \$12.95 |
| #-4012 | Idaho | \$12.95 |
| #-4027 | Montana | \$12.95 |
| #-4023 | Nevada | \$12.95 |
| #-4030 | New Mexico | \$12.95 |
| #-4014 | Oregon | \$12.95 |
| #4032 | Utah | \$12.95 |
| #-4016 | Washington | \$12.95 |

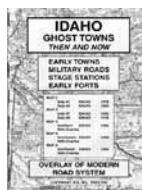

THE RED LIGHT LADIES OF VIRGINIA CITY NEVADA

Prostitution was legal in Virginia City Nevada from 1859 to 1947 and from 1860 to 1882 it was the richest mining town in America. This created the backdrop for the true stories of the lives, deaths and legends of the prostitutes. George Williams III, 47 pages.

#-6176 **\$6.95**



Montana Pay Dirt: A Guide to the Mining Camps of the Treasure State

The stories of the people and the mines that formed the mining camps of Montana. Divides the state into 22 mining districts and then thoroughly looks at the history of the rise and fall of all the significant mining camps in each district. Muriel Sibell Wolle, 435 pages, 8 1/2 x 11 inches with a soft cover.

#-4056 **\$34.95**

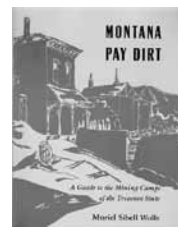

DUST IN THE WIND

A coast to tour of significant ghost town sites. The US is divided into regions and a short synopsis of each site is provided. This book is nicely illustrated with black and white photographs. It is a treasure trove of information for any serious ghost town enthusiast, treasure hunter or metal detectorist. Gary Speck, 5 1/2 x 8 1/2 inches, soft cover with 255 pages.

#-4052 **\$19.95**



NEVADA GHOST TOWN AND MINING CAMPS

Detailed history and historical photos of more than 575 mining sites and towns. Hard cover. Paher, 492 pages. #-5807 **\$49.95**

NEVADA GHOST TOWN TRAILS

This book offers photos and maps with detailed mileage to 139 ghost towns in the great mining state of Nevada. Illustrated. Broman, 80 pages.

#-5365 **\$7.95**

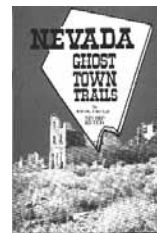

THE GUIDE TO BODIE and Eastern Sierra Historic Sites

The gold discovery in Bodie in 1859, the murder of its discoverer, the boom of 1879 and its long decline. Covers all the neighboring sites of the Eastern Sierras with lots of pictures. Williams, 72 pages.

#-6177 **\$12.95**





Metal Detectors & Accessories



The Lobo SuperTRAQ is simply one of the finest gold nugget metal detectors you can buy. Tesoro's SuperTRAQ Computerized Ground Tracking System

solves the detectorist's greatest problem which is the manual ground balancing procedure. No matter where you hunt, the Lobo SuperTRAQ will quickly self-adjust to eliminate minerals letting you find more gold. Discrimination circuitry with instant pinpointing at your fingertips takes the awesome power of the Lobo SuperTRAQ into every type of metal detecting you do. #T-TD025G msrp \$799.00

- SuperTRAQ Computerized Ground Tracking System
- VLF 17.5 kHz Frequency
- Pole or Body Mount
- 10" Elliptical Widescan Coil
- Three Ground Tracking Modes: Normal Soil, Alkali, Black Sand
- Ultra-Smooth Operation in Extreme Mineralization
- MAXBoost Sensitivity
- 3-piece Knockdown Pole
- Silent Search Discriminate Mode



Lifetime Warranty



If you want to buy one metal detector that will fill your needs as a manual ground balance nugget shooter and a discriminating coin/relic detector then this is your baby. #T-TD043 msrp \$525.00

Relic hunters and prospectors want an adjustable ground balance. Competition hunters want a frequency shifter. Everyone wants a push button pinpoint to make targets easier to dig. The Tesoro engineers have combined all of these features into one machine that will handle just about any type of terrain that you may encounter. No other detector can match the Vaquero for adaptability, sensitivity and survivability.

- MicroMAX Design
- VLF 14 kHz Frequency
- One Drop-in 9V Battery
- Variable Threshold
- 3 3/4 Turn External Ground Balance
- Ultra-lightweight Design
- 9x8 Monolithic Coil
- 3-Piece Knockdown Pole
- Lifetime Warranty

Lifetime Warranty



The Tejón was designed from the ground up with the coin and relic hunter in mind but the high frequency and manual ground balance feature qualify it as a respectable gold prospecting detector. The Tejón has two discriminate modes that are fully user definable. The regular discriminate also incorporates a full-time all metal setting. Want to hunt in all metal and check the targets for iron or discriminate out iron and perform a check for high value silver or gold targets? It's no problem for the Tejón. Push the trigger forward to activate the Alternate Discriminate or pull the trigger back to pinpoint the target. But the user definable features do not stop there. The Tejón has a manually adjustable ground balance that works for both the All Metal mode and both Discriminate modes. #T-TD040 msrp \$699.00

- Dual ED180 Discrimination Circuits
- Easy To Use Trigger Mode Switch
- MAXBoost Sensitivity Adjustable
- 3 3/4 Turn Ground Control

- Compatible With Lobo SuperTRAQ Coil
- Operating Frequency 17.2 to 17.6 kHz
- Searchcoil Size 9 x 8

Lifetime Warranty



The Tesoro Compadre was designed with the idea that less is more. It works great for coin hunting, competition hunting and relic hunting. Switch on the detector and you're working in a silent search, motion all metal mode. The farther you turn the knob, the more discrimination you can bring to bear on those trashy sites. #T-TD033 msrp \$189.00

- VLF 12 kHz Frequency
- Silent Search All Metal and Single Knob Simplicity
- 5.75" Concentric Coil
- 3-Piece Knockdown Pole
- Lifetime Warranty

Lifetime Warranty



The Tesoro Silver μMax offers strong, silent and simple operation. The Silver μMax uses a microprocessor to control the audio tone and battery test. It will come with an 8" Concentric coil and our latest plastic faceplate.



#T-TD037 msrp \$299.00

- VLF 10 kHz Frequency
- Adjustable sensitivity
- One Drop-in 9 volt Battery
- Push Button Battery Test
- Silent Search Discriminate Mode
- Silent Search All Metal Mode
- 8" Concentric Coil

Lifetime Warranty



The Tesoro Cibola combines H.O.T. circuitry with turn-on-and-go simplicity. The Cibola's main search mode is an ED 180 Silent Search discriminate. A threshold-based All Metal is accessed by the Push Button Pinpoint mode. #T-TD042 msrp \$425.00

- Multiple Frequency
- Pushbutton Pinpoint
- One Drop-in 9V Battery
- Variable Threshold
- Ultra-lightweight Design
- 9x8 Monolithic Coil
- 3-Piece Knockdown Pole

Lifetime Warranty





The Tesoro Cortez is a microprocessor controlled metal detector that combines state-of-the-art digital target identification with easy to use analog controls. With the Cortez you do not need endless books and videos to "unlock" it's secrets. Simply

turn it on and your ready to hunt. In the discriminate mode the ground balance is preset so there is no need to fiddle with a bunch of controls. For the more experienced user, who may be searching in more difficult ground conditions, the ALL Metal mode offers a fully adjustable ground balance to cope with almost any soil mineralization. #T-TD038 msrp \$849.00

- Microprocessor Controlled**
- Digital Target ID**
- Two Digit Target ID 0-95**
- Coin Depth and Battery Level Indicators**
- Multiple Tone Target ID**
- Operating Frequency 10 kHz**
- Search coil Size 9 x 8 Concentric**
- Weight (may vary slightly) 2.98 lbs.**
- Battery Requirement Eight AA (alkaline)**

- Battery Life (typical) 10 to 20 hours**
- Operating Modes: No Motion All Metal**
- Silent Search Discriminate- Sum**
- Notch Narrow/Wide**



Lifetime Warranty



The Tesoro DeLeón is a Target Identification Detector or T.I.D. The DeLeón is designed as an easy to use, turn-on-and-go detector. The faceplate has only four controls: Sensitivity, Discriminate, Threshold and a Mode Switch. It uses the same circuitry as the Cortez, so you can expect the same depth and sensitivity from the DeLeón that the Cortez is well known for. The DeLeón's display screen is one character high by eight characters wide. The DeLeón has a Coin Depth reading, a five segment bar graph and a two-digit Target ID Number. The bar graph shows several categories for ID purposes. #T-TD041 msrp \$599.00



Lifetime Warranty

- Microprocessor Control**
- Digital Target ID**
- Two Digit Target ID Number**
- Coin Depth Indicator**
- Operating Frequency 10 kHz**
- Searchcoil Concentric Searchcoil Size 9 x 8**
- Weight (may vary slightly) 2.98 lbs**



- Battery Requirement Eight AA (alkaline)**
- Battery Life (typical) 10 to 20 hours Optimum**
- Operating Modes: No Motion**
- All Metal & Silent Search Discriminate**



The Tesoro Golden μMax has full size depth, sensitivity, Four Tone Audio ID and a user adjustable Notch Filter Discriminate all placed into the lightest detector housing on the market. At less than 2 ½ pounds, the Golden μMax lets you control what you want to find. #T-TD034 msrp \$529.00

- MicroMAX Design**
- Low Noise Circuitry**
- 9 x 8 Coil**
- VLF 10 kHz Frequency**
- One Drop-in 9 volt Battery**
- Silent Search Discriminate Mode**
- No-Motion All Metal Mode**
- 4 Tone Audio ID**
- Positive Pole Locking System**

Lifetime Warranty



The waterproof Tesoro Sand Shark combines time-proven PI circuits with the latest digital technology creating an excellent microprocessor controlled PI detector. Pulse Induction (PI) detectors have always been the natural choice for working wet salt beaches. Their circuitry and single loop coils will not see changes in saltwater conductivity that drive a VLF-style detector crazy. #T-TD030 msrp \$679.00 with an 8" coil #T-TD031 msrp \$709.00 with a 10.5" coil

- Maximum Depth: 200 ft.**
- 600 pps Operating Frequency**
- Weights Less Than 4-1/2 lbs.**
- Modes: VCO Motion All Metal**
- Adjustable Frequency**
- All-Metal Uses 8 AA Batteries**



Stereo Piezo Headphones

Lifetime Warranty



The waterproof Tesoro Tiger Shark uses microprocessor technology to create a true dual function machine. In Normal Mode, the Tiger Shark works like any other Tesoro detector with the same great ground balance and discrimination features. On land, the Tiger Shark can be used for coin and relic hunting and even gold prospecting. It also has a salt water mode. #T-TD032 msrp \$749.00 with an 8" coil #T-TD029 msrp \$779.00 with a 10.5" coil

- Interchangeable Coils**
- Normal & Salt Operating Modes**
- Waterproof to 200 feet**
- Built-in Headphones**
- Ground Balance Control**
- Expanded Discrimination**



Stereo Piezo Headphones

Lifetime Warranty

Garrett Metal Detectors and Accessories

ATGOLD

Deep-seeking true all metal mode performance for All Terrain prospecting!

Includes:

- 5"X8"(14x20cm) PROformance™ DD submersible searchcoil
- Garrett MasterSound headphones
- 10" BackPacker Gold Pan
- You Can Find Gold With a Metal Detector (Garrett/Legal book)
- Gold Guzzler Bottle
- Recovery tweezers /magnifier
- Two (2) gold collection vials
- Highly Recommended - Prospecting ,Coin , Jewelry, Cache Hunting, Relic Hunting, Organized Hunts and Shallow Fresh Water Hunting
- Not recommended for saltwater use or surf hunting
- Includes 18kHz frequency for enhanced detection of small gold nuggets, jewelry, coins and relics!



Waterproof to 10 feet

AT Gold
#G-1140682

\$799.95



ATPRO

This all-terrain detector offers new and exclusive Garrett technology that makes it ideal for hunting coins, relics, caches, jewelry, and even gold nuggets. Select from either Standard or Professional search modes with enhanced audio features.

Includes:

- 8.5 x 11 inches PROformance™ DD submersible searchcoil
- Premium volume-control land headphones
- Highly Recommended - Coin Hunting, Jewelry Hunting, Relic Hunting, Cache Hunting, Prospecting, Ghost Town Hunting, Competition Events, Beach/Fresh Water Hunting

Waterproof to 10 feet

AT PRO
#G-1140460

\$699.95



Waterproof Headphones

All of the detectors on this page come with standard land headphones that are not waterproof. If you plan to submerge the headphones you need these Garrett waterproof headphones that will work with any detector on this page.

#G-2202100 **\$99.95**



UNDERWATER METAL DETECTORS

GARRETT INFINIUM LS

IT WILL CHANGE THE WAY YOU PROSPECT FOR GOLD, HUNT FOR TREASURE ON THE LAND, IN THE SEA, AND EVERYWHERE IN BETWEEN.

The Garrett Infinium LS is a completely new kind of detector, one the industry has never before seen, featuring Advanced Pulse Induction™ (API) technology, the industry's greatest innovation in years. Experience the convergence of the best metal detecting technologies available, and find out for yourself what everyone's been talking about. This new technology, teamed with the remarkable Power DD™ searchcoil, provides treasure hunters everywhere with the most stable, rigid and performance-packed detector in the world.

#G-1152070 **msrp \$1250.00**

POWERFUL MINERALIZED GROUND MACHINE

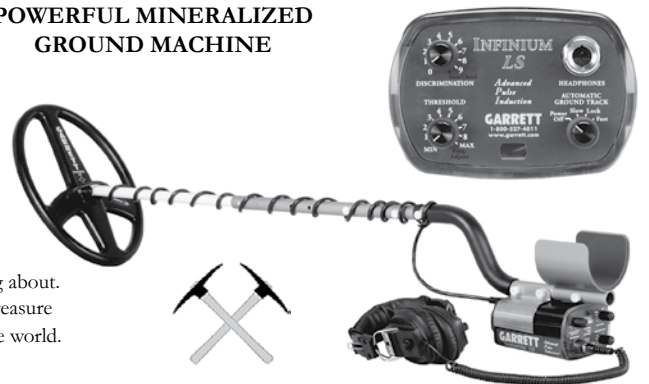

Discrete Trash Elimination technology.
Can be used underwater with a short stem
Can be used on the beach with its long stem configuration.
Electronic housing may be mounted above, below or under the cuff.
A favorite detector for underwater treasure hunters.

Sea Hunter Mark II

#G-1151970 **msrp \$749.95**



GARRETT SEA HUNTER MARK II

Leave the beach for land lovers and go on an underwater adventure with the Sea Hunter Mark II. This high performance underwater detector is all the inspiration you need to set off on a quest for sunken treasure. With Discrete Trash Elimination technology the Sea Hunter can eliminate most pulltabs and foil without significantly degrading the sensitivity of rings and coins in the Discrete Elimination Mode. A favorite detector for treasure hunters around the world, the Sea Hunter can be used underwater with a short stem or on the beach with its long stem configuration. Its electronic housing may be mounted above, below or under the cuff in either short or long stem configuration. It may also be carried in the belt pouch provided.



GARRETT Graphic Target Imaging - GTI SERIES

The Graphic Target Imaging (GTI) Series is planted firmly at the crossroads of pure engineering genius and unexploited treasure hunting adventure. Make no mistake about it, the GTI 2500 and 1500 are the highest performing metal detectors on the market! How can we be so confident in our GTI detectors? Because unlike all other detectors out there, the GTI 2500 and 1500 offer you True Imaging features. That means you get unparalleled Target ID as well as True Size and Depth driven by high performance Digital Signal Processing (DSP) technology.

GARRETT GTI 2500

TEN exclusive and patented features.

Outstanding features like PowerMaster, ScanTrack, and TreasureVision.

Garrett's patented Graphic Target Imaging (GTI) LCD screen.

Garrett's exclusive Graphic Target Analyzing (GTA) technology.

High-performance of true Digital Signal Processing (DSP).

#G-1120570 **msrp \$1099.95**

GARRETT GTI 1500

World's foremost coin shooter.

Instant feedback capabilities.

Indicates target's size, depth and pinpoint location.

Lets you know if a target is a coin or drink can. #-1121070 **msrp \$799.95**



GTI 2500

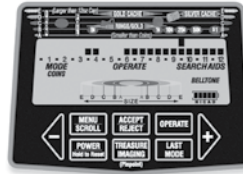

GTI 1500



GARRETT GTP 1350

When treasure hunting, knowing the size of a buried target may mean the difference between digging trash and digging treasure! That's why you need Garrett's ALL NEW Graphic Target Profiling (GTP) 1350. The GTP 1350 is packed with many of the same amazing technologies that are featured in Garrett's elite GTI series. And it offers exclusive profiling technology that identifies the size (Small, Medium, Large) of a target on the LCD display. The GTP also comes with Garrett's ALL NEW, highly rugged 7x10" PROformance searchcoil, which means you search deeper and cover more ground per sweep than with traditional coils.

#G-1152130 **msrp \$699.95**

ALL NEW Graphic Target Profiling detector.

Powerful, DSP-based machine.

Dynamic target size information - (Small, Medium, Large).

Garrett's new RHINO TOUGH 7x10" PROformance.

Elliptical searchcoil.

Highest performing, deepest seeking and most advanced metal detector in its price range.

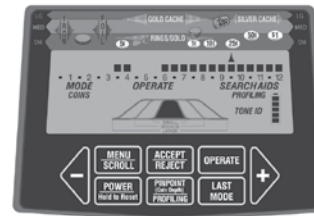

ACE 350 Target ID Metal Detector

The newest member of the world-famous Garrett Ace Series this detector includes the best features of the ACE 250 but adds a powerful new DD searchcoil enhanced iron discrimination and a higher frequency.

Includes:

8.5 x 11 inches PROformance™ DD submersible searchcoil

Garrett ClearSound Easy Stow Headphones

Highly Recommended - Coin Hunting, Jewelry Hunting, Relic Hunting, Competition Events, Dry Beach/Fresh Water Hunting

#G-1140260 **\$349.95**

2 Year Warranty



Garrett Easy Stow headphones are included.



ACE 150 Target ID Metal Detector

New from Garrett the ACE 150 features all the features you look for in an advanced detector including target id, adjustable discrimination, and coin depth.

#G-1138070

msrp \$179.95

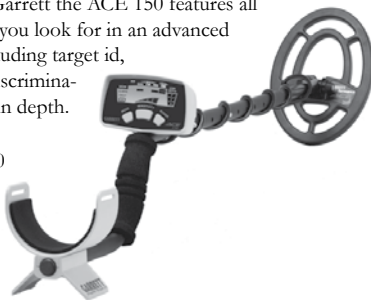

2 Year Warranty

ACE 250 Target ID Metal Detector

The Garrett the ACE 250 has all the features you look for in an advanced detector including target id, adjustable discrimination, and coin depth. #G-1139070 **msrp \$249.95**

Graphic Target ID Cursor (12 Segments)

Discrimination: Accept / Reject Notch

Electronic Pinpoint

Sensitivity, Depth Adjustment (8 Settings)

Coin Depth Indicator

Large LCD Display

Microprocessor Controlled

Push Button Controls

Tone ID, 3 levels



2 Year Warranty



Fisher Metal Detectors

Fisher F2

The newest addition to the Fisher Digital Target ID metal detector line. Packed with the most desirable features in a coin-relic metal detector at a very low price.

- 8-segment visual target identification
- 4-tone audio target identification
- Fast, sensitive target response
- 2-digit numeric target value
- Pinpoint with numeric depth readout
- Coin depth in motion search mode
- 8 inch concentric searchcoil
- 2.6 pounds including batteries
- Ergonomic S-handle design
- Notch discrimination



#F-F2
msrp \$249.00

Fisher F4

#F-F4
msrp \$449.00

Fishers affordable digital solution to your metal detector problems. The perfectly balanced machine is the perfect balance of features and cost. This quality digital metal detector gives you more bang for your buck. It is loaded with features in a compact, lightweight, user friendly package.



- 11-Segment digital target identification and 4-tone audio feedback
- 2-digit numeric target value
- One-touch notch immediately eliminates unwanted targets
- Fisher's deep-seeking auto-tune mode
- One-touch pinpoint
- Coin depth indicator

Fisher F-Point Pinpointer

The Fisher F-Point is basically a small metal detector used to pinpoint the exact location of metal objects. It can be used along with a standard metal detector to determine the exact location of coins or other small targets. It can also be used alone as a stud finder, or any project requiring you to know the exact location of any metal object.



#F-FPoint msrp \$69.00

Fisher F5

Combining the best analog and digital technology with a 10 inch elliptical coil.

- * All metal mode for deep searching in non-trashy areas.
- * Target ID with confidence bar graph.
- * High resolution manual ground balance.
- * Ground balance range goes all the way to salt.
- * Continuous display of ground condition and phase.
- * Push-button pinpoint w/ variable pitch and depth.
- * Independent gain and threshold knobs.
- * 40 hours of operation on two 9 volt batteries.
- * Operating frequency 7.8 kHz



#F-F5
\$549.00

Fisher F70

The Fisher F70 Metal Detector delivers advanced performance at a reasonable price. Lightweight, with superb battery life, accurate ID, and great depth, the F70 makes a great primary detector or backup for your F75.

- * Frequency shift for eliminating interference.
- * Detailed visual target ID & superb depth
- * Discrimination responsiveness for serious hunting under difficult conditions
- * Waterproof coil & versatile controls to cancel out interference from salt water
- * Independent threshold and sensitivity controls
- * Large LCD Screen with target ID
- * Low operating cost with 40+ hours on 4 AA batteries



13 kHz

Standard
10 inch
Elliptical Coil

#F-F70
\$799.00

Fisher F75

#F-F75 msrp \$1249.00

Fishers new state of the art target ID metal detector. The F75 is the most advanced digital metal detector that Fisher has ever offered in it's superb line up of quality machines. The problems that metal detectorist face like bad ground mineralization, junky areas, and deep target ID are all behind you with this sophisticated, but user friendly, machine.

- Best ergonomics in the industry-period.
- Phenomenal target separation and "see through" F75 Metal Detector Fisher Labs 75 Years Special Edition
- Large LCD Screen with Target Identification Discrimination modes for searching in trashy areas
- Ground Cancellation Trigger-Actuated FASTGRAB
- Magnetic Mineralization Bar Graph Read Out
- Trigger-actuated target pinpointing with variable audio pitch
- Nonvolatile memory saves settings
- Superior Electrical Interference Rejection
- Backlight



13 kHz

Standard
10 inch
Elliptical Coil

Low Operating Cost - More than 30 hours with 4-AA Batteries

GOLD BUG PRO The newest Gold Bug has revolutionized gold prospecting machines in performance and price. Unlike other specialized gold prospecting machines, this unit hunts it all; relics, coins and jewelry. Experience the freedom and excitement of searching for all types of treasure. Automatic or manual ground balance to handle the toughest ground mineralization plus super sensitivity adds up to a great nugget detector. Discrimination and target ID make it a great all around machine.

Threshold and Gain Adjustments
1/4 and 1/8 Inch Headphone Jacks

Lightest Weight

2 Search Modes: All-Metal and Discriminate
Large LCD Screen

0-99 Numeric Target Identification Display

Large Target Alert

Depth Readout and Running Signal Strength Indicator

No-Motion Pinpoint

Ground Grab and Manual Ground Balance Options

Continuous Ground Phase and Ground Mineralization Readout

2 Tone VCO

Super Sensitive

#F-GoldBug-Pro with 5 inch DD widescan coil msrp \$699.00



GOLD BUG The basic Gold Bug is essentially the same as the Gold Bug Pro with a few less features. For the prospector on a budget it is the perfect tool. A few less discrimination features and the lack of manual ground balance are the basic difference between the standard Gold Bug and the Gold Bug Pro. The automatic ground balance will still handle the toughest ground mineralization and the super sensitivity adds up to a great nugget detector. Discrimination and target ID make it a great all around machine.



#F-GoldBug
\$549.99

with 5 inch
 DD Coil

Fisher GOLD BUG 2

Take prospecting to new levels with the second generation of Gold Bug, the ultra high frequency Gold Bug-2. The Gold Bug-2 is designed for finding gold nuggets. It offers extraordinary sensitivity, ultrahigh frequency (the highest operating frequency on the market), iron-discrimination, dust and moisture resistance, audio-boost and the ability to operate in extremely mineralized soil with a 3 position mineralization switch.

Powerful 71 kHz Operation for extreme sensitivity to small gold nuggets
"IRON DISC" mode rejects iron (trash) targets and hot rocks. Resistant to dust and moisture

Boosts audio signal of small and deep targets

Convertible to hip mount or chest mount

Weights only 2.9 lbs.

Quartz-crystal locked electronics.

Dual-knob ground control for coarse and fine adjustment.



71 kHz
for super
sensitivity



#F-GB2-6

with 6 inch coil msrp

\$899.99

#F-GB2-10

with 10 inch coil msrp

\$899.99

#F-GB2-Combo

with 6 & 10 inch coils msrp

\$999.99

Decades of proven world wide gold recovery!

Fisher 1280-X Under Water All-Purpose Metal Detector

Discriminating, simple to use, rugged & affordable. The deep-seeking, submersible, Aquanaut features automatic turn on-and-go operation for salt water, fresh water or land use. VLF discrimination, target strength LED and our patented quartz-crystal circuitry offers up to 75 hours of battery life. For added ease of use, the control box converts to a belt mount.

#F-1280X-8 with 8 inch coil **\$799.95**

#F-1280x-10 with 10 inch coil **\$829.95**

Submersible for Underwater Treasure Hunts.
Automatic turn-on-and-go operation.
Salt water, fresh water or land use
Leakproof to 250 feet.
Up to 75 hours of battery life.

Ignores small pieces of trash
Patented quartz-crystal circuitry.
Converts to belt mount.
Audio and visual target response
Adjustable Sensitivity control.



Full Range Target Discrimination.
Built-in headphones.
Weights 5.1 pounds.

Fisher GEMINI-3

Fishers two box has a reputation for being the best. Goes deeper, & traces farther! Two box treasure hunters know that Fisher's Gemini-3 has a reputation for being the best there is. Designed to locate deep objects; depending on ground mineralization and target size objects may be detected as deep as 20 feet! The Gemini-3 goes deeper, traces farther and is easier to use than any other cache finder in its class.

Find deep
metal objects
or trace buried
wire and pipes.

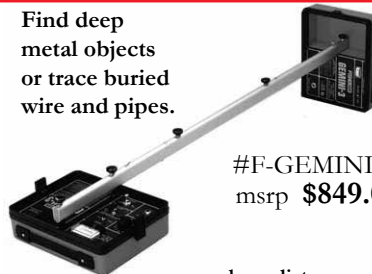

#F-GEMINI3
 msrp **\$849.00**



Detects all metals: Sensitive to large, deep objects or ore veins.
Crystal controlled: 82 kHz transmitter and receiver.

Four mode operation: Inductive Trace, Conductive Trace, Wide Scan Inductive Trace and Narrow Scan Inductive Trace. • Optional Ground Plate Assembly for

long distance underground tracing
60 cycle noise reduction circuitry
VCO audio target response for precision pinpointing.
Operates on standard AA batteries

The Treasure Mate Pinpointer

Treasure Mate Pinpointer

The Treasure Mate Pinpointer is a small hand held super sensitive metal detector that can be used for pinpointing coin and relic targets or for gold prospecting. It is very light weighing, only 6 ounces, but at 16.5 khz it is sensitive enough to locate very small pieces of placer gold. Comes complete with a deluxe detector belt pouch. #-5542 **\$179.00**

This is the pinpointer that is sensitive enough and equipped with circuitry to deal with harsh ground mineralization so that it can be used for gold prospecting.

Limited Lifetime Warranty



Free Belt and Recovery Pouch to carry your tools and finds are included.



DETECTOR ACCESSORIES



- A**  **#-5008**
- B**  **#-5009**
- C**  **#-5010**
- D**  **#-5011**
- E**  **#-5012**

WILCOX STAINLESS STEEL DIGGING TOOLS

For those who prefer heavy duty (MADE IN THE U.S.A.) construction with economic pricing. The handles cannot separate from the tool because they are constructed of one solid piece of stainless steel. These tools have a depth gauge inscribed on the back. Non-slip vinyl hand grip.

Wilcox Quality Digging Tools

- (A) #-5008 10" long x 3" wide **\$10.95**
- (B) #-5009 9" long x 1.5" wide **\$ 9.95**
- (C) #-5010 11" long x 3 in wide **\$13.25**
- (D) #-5011 12" long x 2 in wide **\$13.25**
- (E) #-5012 14" long x 3" wide **\$14.25**

RHINO TOUGH Trowels

This rugged plastic trowel is 3 1/2 inches wide and 12 inches long. It is made out of an extremely tough PVC plastic. It is the perfect nonconductive digging tool for all types of metal detecting.

#-6517 **\$2.98**

Same as above except about 1/2 inch longer with a narrower blade. #-6519

\$2.98



WILCOX ALL-PRO

11" Digging Trowel with Side Cutting Edges

\$17.25



This quality stainless steel digging tool is 11 inches long and 3 inches wide. The Wilcox patented one-piece construction insures years of reliable service. This tool has a very sharp edges and point to take on the most challenging digging situations in sod and roots. #-5027 **\$17.25**

Garrett Coin Probe: #G-1605800

Will quickly find targets in grass with minimal digging. Polished tip reduces the chance of damage to valuable targets.

\$8.95



Lesche Digger

Designed to attack any kind of hard packed dirt or the toughest tangled roots with the metal detectorist in mind. Lightweight and strong, made of nearly indestructible Chrome-Moly steel with a generous hand guard. A tough cordura belt sheath is included. #-5013 **\$49.95**



Garrett Pro-Pointer

The Garrett Pro-Pointer is the Cadillac of target pinpointers. It features a proportional audio/vibration pulse rate that increases as you get closer to the target. It features completely automatic tuning, a 360 degree detection area, an LED for low light areas, and a belt holster is included.



#G-1166000
msrp **\$149.95**

JOBE DIG-IT

The "JOBE Dig-It incorporates the 3 in 1 design, long a favorite among detectorist, with a high quality steel blade. The handle is comfortable & Durable.

The digging tool is eleven inches long from tip to tip! It comes complete with a thick cowhide sheath that is both sewn and riveted to last. The sheath has belt slots as well as a spring steel belt clip. The blade is concave for scooping with a saw-tooth section to cut roots. #-5509 **\$32.95**



Deluxe Brass Coin Probe

Hand crafted brass coin probe with a 1 1/4 inch porcelain ball handle. The brass probe is designed to not scratch valuable finds.

#-5603 **\$10.95**

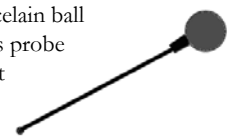

Jim Dandy Beach Scoops

Need a tool that will dig through beach sand, including wet sand? Need to grab targets quickly from the sand, to beat the surf, while standing? Need to dig deep targets quickly? Look no further as this is why God invented our JIM DANDY zinc plated steel beach scoops. A precision stamped steel basket goes through sand like the scoop had no bottom, while the steel mesh captures even the smallest coins or jewelry. Quick target recovery means more treasure and stand up recovery means less fatigue. These scoops are available with a hand grip attached to the basket, a 10 inch handle, a 28 inch handle, or with a dual length handle. All the scoops are made of 18 gauge cold rolled steel, are 5 inches in diameter, and 9 inches long.



#-5574 attached handle **\$29.95**

#-5575 10 inch handle **\$44.95**

#-5576 28 inch handle **\$49.95**



#-5577

Dual Handle **\$69.95**

The Sand Witch and The Dune Doctor

The Sand Witch Flies Through Sand. These rugged steel sand scoops are designed to skim the surface picking up targets for detectorist or debris from the surface of the sand with minimal penetration. For beach or playground maintenance they are perfect for removing trash, broken glass, cigarette butts, oil soaked sand, or tar while allowing clean sand to pass through. The Sand Witch is designed with a wide flat cutting surface to maximize surface coverage and minimize digging. They are all zinc plated steel and are available with a 10 inch or a 28 inch handle with a comfortable foam grip. The opening is 5 1/4 inches wide and 3 1/2 inches tall, weighs only 28 ounces with the 10 inch handle and 36 ounces with the 28 inch handle.



The Dune Doctor is a serious beach tool. The basket opening is 12 inches wide and 4 inches high, yet the entire weight of the tool is only 4 pounds including a 42 inch fiberglass handle. The **Dune Doctor** can be configured in either a rake or shovel mode in seconds by moving one bolt. Either way, it efficiently skims debris off the surface, capturing it in the steel basket. A quick shake allows the clean sand to pass through the 1/2 inch square holes, and then a quick turn of the wrist drops the debris out into an appropriate receptacle. Used in archeological digs, removing numerous junk targets, and beach maintenance.



#-5563 **\$64.95**

#-5560 10 inch handle. **\$44.95**

#-5561 28 inch handle. **\$49.95**



Other Sand Scoops

RTG PRO ALUMINUM MINI TRAVEL WATER SCOOP

Need a light duty shallow water and beach scoop built to travel? Made in the U.S.A. by Reilly's Treasured Gold the aluminum bucket has 5/8" diameter holes punched into the sides and the back of the scoop. The bucket of the sand scoop is 5" in diameter by 9" long. The aluminum 1-1/4" diameter handle is welded at a 20 degree angle so you can use your foot on the back of this scoop to push it into the sand. The scoop handle comes apart at the middle for traveling purposes. There is a reinforced aluminum brace to give this scoop added durability. The assembled handle is 40" long with a rubber grip, making the over length of this scoop approximately 47". Total weight is only 3-1/2 pounds with a 90 day limited warranty against manufacturing defects.

(Reilly's # 733trv)

#-5504

\$119.95



Wilcox Sand Scoop

This durable yellow plastic sand scoop is our lowest priced sand scoop.

#-6205 **\$13.95**

Basic Sand Scoop

Light duty galvanized steel construction for years of service. This scoop is 9 inches long and 5 1/2 inches in diameter. Designed to quickly identify targets in sand or loose dirt with 1/2 inch holes.

#-5029 **\$17.95**



Garrett Steel Sand Scoop

This quality steel beach scoop from Garrett will give you years of service recovering coins and jewelry from sand. It is available in a plated steel and a stainless steel version.

#G-1600970 Plated Steel **\$39.95**

#G-1600900 Stainless Steel **\$59.95**



TREASURE SCOOP

Reinforced plastic scoop designed to recover nuggets and help you locate them in the scoop with your detector. Available in green, and black.

#-5548 **\$7.95**



Detector Target Cup

This green plastic cup is designed for helping you recover targets with your metal detector. It is 4 inches wide, 6 inches long and 2 1/2 inches deep.

#-5547 **\$2.95**



The Groundhog Detector Pick

Made in the USA this heavy duty detector pick has a hardwood handle with a rubber grip. The pick / mattock steel head is 9 inches long and 2 1/4 inches wide on the mattock side. The tool has an overall length of 18 inches and weighs only 1 3/4 pounds. A powerful super magnet is included and attached to the top of the tool.

#-5602

\$44.95



American Steel

DOUBLE FOLDING SHOVEL

Tempered steel shovel fully extends to 23 1/2" and folds to a compact 9" x 6". Can be configured as a hoe, shovel, stool or root saw. All steel construction.

#-5056 **\$12.95**

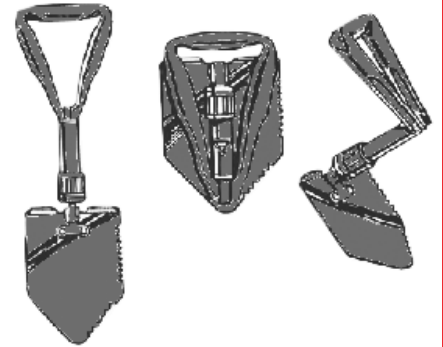

THE BOSS Detector Pick

A 4 1/2 inch wide x 9 inch hardened steel head attached to a 22 inch long American Hickory handle makes for a serious digging tool. Weighing only 2.3 pounds it is perfect for metal detecting.

#-5590 **\$59.95**



SWIVEL LEATHER PICK HOLDER

Works on all the detector picks.

#-6028 **\$2.98**

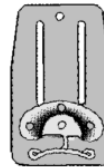

HAMMER HOLDER

Specially designed to work with all detector picks especially with super magnets. This heavy black webbing material holds the hammer quietly and has no metal parts for the super magnet to grab.

#-5772 **\$7.50**

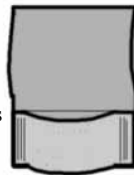

MINI SHOVEL / PICK

This sturdy miniature folding shovel is perfect for metal detecting, rock collecting and gold prospecting. With a two piece handle it easily breaks down into a compact kit.

#-5694 **\$9.95**

#-5580 **\$39.95**

JOBE Treasure Pick / Mattock

When you need a little bit more serious digging tool for your prospecting, treasure hunting and metal detecting adventures. This drop forged steel head is 10 inches long and the mattock edge is 3 1/4 inches wide. The overall length is 19 inches with a durable fiberglass handle and a rubberized hand grip. A powerful super magnet is attached to the top of the tool to grab all those pesky junk iron targets. The total weight is about 2 pounds.



Super Magnet



DETECTOR HEADPHONES

CAL RAD 32 ohm DETECTOR HEADPHONES

Cal Rad detector headphones are the standard headphones for nugget hunters. They are lightweight, comfortable and switchable from mono to stereo. The independent volume control on each ear make them a perfect match for any detector.

#-5104 **\$49.95**



Garrett Master Sound 8 ohm Stereo Headphones

These comfortable headphones are built for metal detecting. They mask noise, boost signals, and find more treasure. Individual volume controls on each ear.

#G-1603000 **\$29.95**



Jolly Roger Headphones

Compact carry and storage foldable design. Heavy-duty polymer muffs with full-ear surround, soft comfortable cushions. Special sound-blocking muff design eliminating environmental ambient noise up to 20 decibels. Frequency response: 150 Hz - 20 kHz. Impedance: 16 ohms nominal. Backed by a limited lifetime warranty.

#-5555 **\$90.00**



Cal Rad 8 OHM Detector Headphones

Comfortable full ear pads, a short cord with 1/4 inch stereo plug. Adjustable volume controls on each ear make these headphones a perfect match for your metal detector. Rated at 8 ohms impedance these are inexpensive but good quality detector headphones.

#-5101 with a straight plug **\$29.95**

#-5102 with an angled plug **\$29.95**

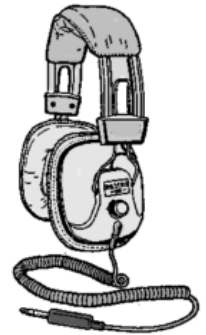

Nugget Busters

Nugget Busters were designed for the demanding professional electronic prospector and gold nugget hunter. If you're just getting started in gold hunting, we're sure you'll never want to use anything but Nugget Busters!

Compact carry and storage foldable design. Heavy-duty polymer muffs with full-ear surround, stay-soft, non-hardening cushions. Adjustable padded headband... no screws, no wire frame, no rust! Speakers designed for maximum sensitivity, efficiency, durability, and signal quality. Special sound-blocking muff design eliminating environmental ambient noise up to 24 decibels. Frequency response: 200 - 3200 Hz... only what your detector uses. Sensitivity: 72 dB @ 1kHz min. Impedance: 150 ohms nominal. Backed by a limited lifetime warranty.

#-5550 **\$109.00**

Lifetime Warranty



Nugget Busters



Folds for compact carry and storage



The Original Gray Ghost is designed for the demanding professional coin, relic, and jewelry hunter. These phones are built by detector people for detector people. The Grey Ghost also has a built in large signal blocker to limit the volume of the response to a large target.

Compact carry and storage foldable design. Heavy-duty polymer muffs with full-ear surround, stay-soft, non-hardening cushions. Adjustable padded headband... no screws, no wire frame, no rust! Speakers designed for maximum sensitivity, efficiency, durability, and signal quality. Special sound-blocking muff design eliminating environmental ambient noise up to 24 decibels. Frequency response: 200 - 3200 Hz... only what your detector uses. Sensitivity: 72 dB @ 1kHz min. Impedance: 150 ohms nominal.

Backed by a limited lifetime warranty.

#-5549 **\$109.00**

Lifetime Warranty



Original Gray Ghost



Folds for compact carry and storage



HEADPHONE TOTE

Made with a durable canvas-like material these are the perfect size to protect your detector headphones in the large zippered pouch. A smaller zippered pouch is also provided for batteries or other accessories. Has an attached handle on the top of the tote and comes with an optional shoulder strap. Tote is 9 inches high, 9 inches tall and 4 inches deep. #-6209 **\$12.95**

Detector Carry Bags

These metal detector carry bags are designed to protect your detector and allow you to carry it fully assembled.

ECONOMY DETECTOR BAG.

Your basic rectangular cut carry bag fits most Fisher, Garrett, and Tesoro metal detectors. #-5082 **\$24.95**

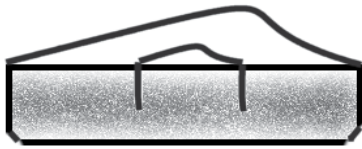

Deluxe Padded Bag

This deluxe padded detector bag is big enough to hold most metal detectors completely assembled. It is 53" long and 18 inches tall and constructed of black 600 denier polyester. It has a full length zipper closure and a 9" x 10" outside pocket

#-5898
\$49.95



Garrett Detectorist 's

Backpack: This rugged backpack is designed to carry any Garrett metal detector, gold pans and all your field accessories. Special coin pouch on the shoulder strap also holds a cellphone.

#G-1651800 **\$59.95**



The All Purpose Carry Bag:

This vinyl all purpose carry bag will protect your assembled Garrett metal detector and accessories.

#G-1608700 **\$29.95**



The Padded 2 Zipper Carry Bag

This vinyl two zipper carry bag is extra large to carry your assembled Garrett metal detector and all your accessories. #G-1608500 **\$69.95**



ACE Detector Sport Tote Bag

#G-1651500 **\$14.95**



23 inches long with shoulder strap and carrying handles. Works with any ACE Series detector.

Tesoro Target Pouch

This rugged target pouch has a large pocket for trash and tools along with a smaller zippered pocket for the good stuff.

#T-AP014 **\$19.95**



JOBE Deluxe Target Pouch

The new recovery pouch is made with a durable black 600 denier polyester fabric. The main pocket for junk and tools has a wide mouth with a mesh bottom so that sand and dirt will fall out. The reinforced mesh sides keep the pocket open for easy access to tools and ease of dropping trash targets and tools into the pouch. There is also a large pocket with a zipper closure for the good stuff.

#-6724 **\$29.95**



JOBE Comfort Zone Tool Belt

This padded 2 inch wide Poly Web Belt is adjustable from 32 to 50 inches and has a quick release buckle. The padding makes for a very comfortable but sturdy tool belt.

#-5699 **\$6.95**



HEAVY DUTY EQUIPMENT BELT

Very stiff Nylon belt is adjustable to 48" and has a durable Delrin quick release buckle. This belt will hip mount your detector without bending under the weight of the detector and the digging tools you carry. One end can be disconnected from the buckle to slide through the belt slit on the detector.

#-5698

\$9.95



Tesoro Padded Detector Bag

This full size padded gun style carry bag will hold any of the Tesoro detectors without disassembly.

#T-AD022 **\$39.95**



Fisher Padded Carry Case

This deluxe padded carry case will carry and protect any Fisher standard Fisher detector without disassembly.

F-103693000c **\$45.00**



Fisher Flying F baseball cap.

#F-8703301000 **\$14.95**



TESORO Metal Detectors baseball cap.

#T-TA040 **\$14.95**



Garrett Metal Detectors baseball cap.

#G-1663300 **\$9.95**



Garrett ACE black baseball cap.

cap.#G-1663100 **\$9.95**



Garrett AT PRO baseball cap.

#G-1663400 **\$9.95**

METAL DETECTING BOOKS

Handbook for Detectorist

A treasure chest of information about metal detectors, techniques, sites, finds and well-kept secrets. This is the best book I have ever seen on metal detecting and is a great value, for both the technical content and artistry. This is a beautiful book with full color glossy pages containing 380 photographs and drawings. There are also over 1000 photographs of spectacular detectorist finds, and all are in full color. The "Handbook for Detectorists" has been published in English, French, German and Dutch. Written from a European perspective it covers the basics for a beginning detectorist and offers numerous well-kept secrets for the pros. Gert Gesink, 350 pages, 6 1/2 x 9 1/2 inches with a soft cover. #4769 \$49.95

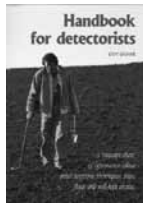

European Metal Detecting Guide

Want to go metal detecting in Europe? How to, where to, techniques, tips, and the laws. Hundreds of color photos of finds and information on clubs. By Stephen L. Moore, 295 pages, with a soft cover. #G-1562100 \$18.95

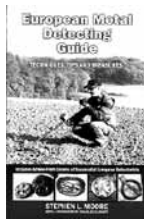

How To Find Lost Treasure:

Handy pocket size guide to finding treasure with a metal detector. Lots of good detecting tips. Charles Garrett, 3 1/2 x 5 inches with 72 pages. #G-1509300 \$3.95



Metal Detecting for the Beginner

All the basic information you need to select and operate any modern metal detector. The features, how to, and where to detect for everything from treasure to gold nuggets. Vince Migliore, 6 x 9 inch, 119 pages with a soft cover. #4771 \$12.95

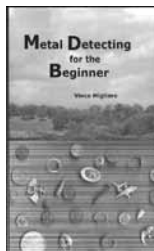

Coin Shooting III

This is an updated version of the old Coinshooting classic by Carson. The author of many treasure hunting books turns his perspective to the art of finding valuable coins with a metal detector. H Glenn Carson, 64 pages, soft cover, 5 1/2 x 8 1/2 inches. #4719 \$9.95

How to Search Sand and Surf: treasure Recovery at the Beach

Charles Garrett, pocket size, 72 pages. #G-1509600 \$3.95



Buried Treasure You Can Find

A book that every treasure hunter and metal detector hobbyist should possess. Lists over 7500 specific known sites of buried treasure in 50 states. Treasure sites are listed by states. Complete information about using the latest, most modern metal detectors. Color photos. Robert F. Marx, 367 pages, soft cover, 5 1/2 x 8 1/2 inches. #G-1500000 \$14.95



Treasure Hunting for Fun & Profit

Treasure hunting is fun and can be profitable. It is truly a hobby that can pay for itself. Treasure Hunting for Fun and Profit explains how simple it is to find coins, gold nuggets and buried treasure with a metal detector. By Charles Garrett, 5 1/2 x 8 1/2 inches, soft cover with 204 pages. #G-1508300 \$9.95



The Beach Hunters Guide

The secrets of the professional beach hunters are clearly revealed. This book covers everything you need know about when, where, and how to detect to bag the bounty of the beach. Donald Barthel, 47 pages 8 1/2 x 11 soft cover. #4731 \$19.95



Detecting South-West Florida

These beaches plus the Saint Augustine and Daytona Beach. Includes maps, check list and ratings on all the best treasure beaches in SW Florida. Donald A. Barthel, 40 pages, soft cover, 8 1/2 x 11 inches. #4735 \$19.95



Detecting South-East Florida

Beach hunters guide to the treasure rich beaches of SE Florida. Barthel & Robinson, 50 pages 8 1/2 x 11 soft cover. #4730 \$19.95



The New: Successful Coin Hunting

Tips to find more coins with less effort using modern metal detectors. Charles Garrett, 260 pages, 5 1/2 x 8 1/2 inches with a soft cover. #G-1501500 \$12.95



The Sport of Coin Hunting with a Metal Detector:

Charles Garrett, pocket size, 84 pages. #G-1509600 \$3.95



INSIDE Treasure Hunting

Buying the right metal detector is critical in successful treasure hunting. Ty does a good job of explaining how a metal detector works, the design criteria of search coils and basic detector controls and features. He also covers the field use of metal detectors with numerous hints and tips from the pro. Ty Brook, 85 pages, 5 1/2 x 8 1/2 inches, soft cover. #4737 \$11.95



Advanced Nugget Shooting

Nuggetshooting is the process of using your metal detector to prospect for gold nuggets. This is an advanced look at the subject that will have something for metal detectorist at all levels. James McCulloch, 20 pages, soft cover, 8 1/2 x 11 inches. #4758 \$6.95

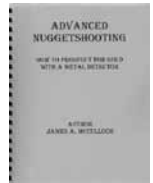

Advanced Prospecting & Detecting For Hard Rock Gold Expanded Meteorite

Using your metal detector to prospect for lode gold. All the inside tips on electronic prospecting for lode and residual placer gold deposits. Revised for 2112 with new information and color photos including an appendix on meteorite hunting. Jim Straight, 117 pages, soft cover, 5 1/2 x 8 1/2 inches. #5493 \$19.95

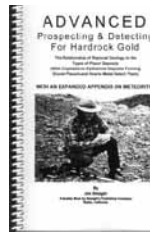

FOLLOW THE DRYWASHERS VOL 3

The new 6th edition of Jim Straight's classic "THE NUGGET SHOOTERS BIBLE". How to, where to, techniques, maps, etc. This book was out of print for a few years but now has been republished by popular demand. 265 pages. #5233 \$29.95



Family Treasure Hunting: Charles Garrett:

A beginners guide to metal detecting for all ages. Charles Garrett, pocket size, 80 pages. #G-1546300 \$3.95



Introduction to Metal Detecting in Europe:

Includes author's personal experiences detecting in Europe. Charles Garrett, pocket size, 76 pages. #G-1546200 \$3.95

Relic Quest

A guide to relic recovery with metal detectors. Full color photographs and illustrations covering hundreds of amazing finds in Europe and the US. Stephen Moore, 6x9 inches, 510 pages, with a soft cover. #G-1510000 **\$22.95**



Coinshooting: How and Where To Do It

The author of many treasure hunting books turns his perspective to the art of finding valuable coins with a metal detector. This is the how and why of metal detecting for coins. The subtitle (Using a metal detector effectively), says it all. H Glenn Carson, 62 pages, soft cover, 5 1/2 x 8 1/2 inches. #-4748 **\$8.95**

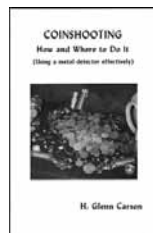

Treasure Caches Can Be Found:

One of the world's leading experts teaches you how to research, locate and recover treasure caches. Legendary tales of the treasures lost by bandits, outlaws, and pirates. Charles Garrett, 5 1/2 x 8 1/2 soft cover with 194 pages. #G-1508600 **\$9.95**



YOU CAN FIND GOLD WITH A METAL DETECTOR:

Charles Garrett and Roy Lagal have been prospecting and metal detecting since Moses was a kid. Here they combine those skills into an informative look at finding gold with modern metal detectors. Look in the right places, Search correctly using state of the art equipment and be patient. A great how to book. Garrett and Lagal, 140 pages. #1545500 **\$9.95**



METAL DETECTING FOR BEGINNERS

The author's long experience detecting is reflected in this straight forward informative book covering every subject you need to address as a beginning detectorist. Selecting equipment, site research, target recovery and accessories are all covered. By Ed Tisdale, 5 1/4 by 8 1/2 inches, soft cover with 68 pages. #4717 **\$14.95**



Detecting Southern California Beaches

This book contains everything you need to know for successful beach detecting in Southern California. Includes directions, photographs and ratings on all the best beaches in Southern California. Information on the effects of storms on these beaches and detailed information on using tide tables to maximize your success are also included. Donald A. Barthel, 58 pages, soft cover, 8 1/2 x 11 inches. #4770 **\$19.95**



FINDING GOLD NUGGETS II

Jimmy Sierra's latest covers everything his original book did and then some. Everything you ever wanted to know about detecting for gold but didn't know who to ask. #4715 **\$9.95**



Treasure Hunting Seek and You Shall Find

A great little book that should be in the library of every treasure hunter. The techniques and the tricks of the trade for successful treasure hunting, including metal detecting for treasure. Eddie Okonowicz, 44 pages, soft cover, 5 1/2 x 8 1/2 inches. #-4749 **\$6.95**



The Urban Treasure Hunter.

Every city contains countless hidden treasures waiting to be discovered. These include lost coins, lost jewelry, hidden caches, historic relics, antique bottles, and hundreds of other sought-after collectables. Learn all about the tools of the trade from metal detectors to shovels. Michael Chaplan, 225 pages, 7 1/2 inches by 9 1/4 inches with a soft cover. #-5372 **\$18.95**



Modern Metal Detectors-Revised

Revised for field and home study for a better understanding of any detector, including computerized models. 432 pages. Charles Garrett #1501700 **\$12.95**

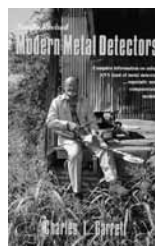

Treasure Hunting A Modern Search for Adventure

Some of the tricks of the trade from one of the original treasure hunters using metal detectors. H. Glenn Carson, 5 1/2 x 8 1/2 inches, 81 pages with a soft cover. #4740 **\$7.95**



Dowsing

DOWSING for BEGINNERS

Covers every aspect of dowsing including simple instructions on how to build your own dowsing equipment for little or no cost. Richard Webster has been there and done that. His book is a hands-on approach with everything you need to know to become a successful dowser. By Richard Webster, 5 1/4 x 8 inches, soft cover with 200 pages. #4711 **\$13.95**

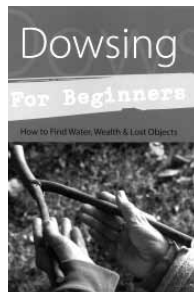

METEORITES

Falling Stars:

A Guide To Meteors and Meteorites

A straightforward and practical guide to all aspects of meteors and meteorites. Covers meteor and meteorite origins, types, showers, craters and classification. Includes chapters on collecting meteorites and tektites. Dr. Mike D. Reynolds, 145 pages, 5 1/2 x 8 1/2 inches, soft cover. #-4727 **\$16.95**

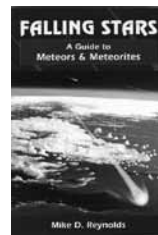

ROCKS FROM SPACE

Everything you ever wanted to know about Meteorites including how and where to look for them with your metal detector. Meteorites can be worth much more than gold, you can find them anywhere and your metal detector is the best tool available to search for them. Written by O. Richard Norton with 446 pages and loads of pictures. #-5348 **\$32.00**



Robert Carion Meteorites

Robert Carion is one of the worlds most aggressive collector of meteorites and he has put together this beautiful new book that is filled with full color glossy photographs of meteorites. This is a must-have book for anyone interested in finding, selling or collecting meteorites. 72 Pages with a soft cover it is 6 x 9 inches. #-6806 **\$19.95**



Meteorite Hunting How To Find Treasure From Space

Geoffrey Notkin of "Meteorite Men" fame has compiled this book that is the comprehensive illustrated guide to recovering, identifying, and understanding meteorites. Detailed information on how to locate, excavate, and identify rocks from space with full color glossy photographs of recovered meteorites. Geoffrey Notkin, 83 pages, 6 x 9 inches with a soft cover. #-6805 **\$24.95**



Meteorite Hunting Full Color DVDs

From The Prospectors's Channel these professionally produced DVDs cover all aspects of meteorite hunting. #8110 Iron From The Sky **\$11.95**
#8154 Franconia Meteorites **\$11.95**

The Value of Gold

Gold has served as the most important monetary standard throughout history. It is measured in troy ounces and the price of gold is typically stated in terms of the cost of one Troy ounce.

Historically, the United States has fixed the price of gold. The price of an ounce of gold was fixed at about \$20.00 from 1786 until 1934, at which point the price was raised to \$35.00. In 1968 a two-tiered pricing structure was established, and by 1975 the price of gold was allowed to fluctuate. On January 21st, 1980 the price of gold reached its peak of \$850, and by the year 2000 the price dropped to \$272.

The Yearly Average Price of Gold in U.S. Dollars from 1833 to 2010

| | | | | | | | | | |
|------|---------|------|---------|------|---------|------|----------|------|-----------|
| 1833 | \$20.65 | 1871 | \$20.65 | 1908 | \$20.67 | 1945 | \$34.71 | 1982 | \$375.87 |
| 1834 | \$20.65 | 1872 | \$20.66 | 1909 | \$20.68 | 1946 | \$34.71 | 1983 | \$425.35 |
| 1835 | \$20.65 | 1873 | \$20.66 | 1910 | \$20.64 | 1947 | \$34.71 | 1984 | \$360.48 |
| 1836 | \$20.65 | 1874 | \$20.66 | 1911 | \$20.64 | 1948 | \$34.71 | 1985 | \$317.26 |
| 1837 | \$20.65 | 1875 | \$20.66 | 1912 | \$20.65 | 1949 | \$31.69 | 1986 | \$367.66 |
| 1838 | \$20.65 | 1876 | \$20.66 | 1913 | \$20.64 | 1950 | \$34.72 | 1987 | \$446.46 |
| 1839 | \$20.65 | 1877 | \$20.66 | 1914 | \$20.72 | 1951 | \$34.72 | 1988 | \$436.94 |
| 1840 | \$20.65 | 1878 | \$20.66 | 1915 | \$20.72 | 1952 | \$34.60 | 1989 | \$381.44 |
| 1841 | \$20.65 | 1879 | \$20.65 | 1916 | \$20.72 | 1953 | \$34.84 | 1990 | \$383.51 |
| 1842 | \$20.65 | 1880 | \$20.66 | 1917 | \$20.72 | 1954 | \$35.04 | 1991 | \$362.11 |
| 1843 | \$20.65 | 1881 | \$20.66 | 1918 | \$20.72 | 1955 | \$35.03 | 1992 | \$343.82 |
| 1844 | \$20.65 | 1882 | \$20.66 | 1919 | \$20.70 | 1956 | \$34.99 | 1993 | \$359.77 |
| 1845 | \$20.65 | 1883 | \$20.66 | 1920 | \$20.68 | 1957 | \$34.95 | 1994 | \$384.00 |
| 1846 | \$20.65 | 1884 | \$20.66 | 1921 | \$20.68 | 1958 | \$35.10 | 1995 | \$384.17 |
| 1847 | \$20.65 | 1885 | \$20.65 | 1922 | \$20.66 | 1959 | \$35.10 | 1996 | \$387.77 |
| 1848 | \$20.65 | 1886 | \$20.65 | 1923 | \$21.32 | 1960 | \$35.27 | 1997 | \$330.98 |
| 1849 | \$20.65 | 1887 | \$20.65 | 1924 | \$20.69 | 1961 | \$35.25 | 1998 | \$294.24 |
| 1850 | \$20.65 | 1888 | \$20.66 | 1925 | \$20.64 | 1962 | \$35.23 | 1999 | \$278.88 |
| 1851 | \$20.65 | 1889 | \$20.65 | 1926 | \$20.63 | 1963 | \$35.09 | 2000 | \$279.11 |
| 1852 | \$20.65 | 1890 | \$20.66 | 1927 | \$20.64 | 1964 | \$35.10 | 2001 | \$271.04 |
| 1853 | \$20.65 | 1891 | \$20.68 | 1928 | \$20.66 | 1965 | \$35.12 | 2002 | \$309.73 |
| 1854 | \$20.65 | 1892 | \$20.68 | 1929 | \$20.63 | 1966 | \$35.13 | 2003 | \$363.38 |
| 1855 | \$20.65 | 1893 | \$20.68 | 1930 | \$20.65 | 1967 | \$34.95 | 2004 | \$409.72 |
| 1856 | \$20.65 | 1894 | \$20.66 | 1931 | \$17.06 | 1968 | \$38.69 | 2005 | \$444.74 |
| 1857 | \$20.65 | 1895 | \$20.65 | 1932 | \$20.69 | 1969 | \$41.09 | 2006 | \$603.46 |
| 1858 | \$20.65 | 1896 | \$20.71 | 1933 | \$26.33 | 1970 | \$35.94 | 2007 | \$685.01 |
| 1859 | \$20.65 | 1897 | \$20.71 | 1934 | \$34.69 | 1971 | \$40.80 | 2008 | \$875.90 |
| 1860 | \$20.65 | 1898 | \$20.71 | 1935 | \$34.84 | 1972 | \$58.16 | 2009 | \$969.88 |
| 1861 | \$20.65 | 1899 | \$20.66 | 1936 | \$34.87 | 1973 | \$97.32 | 2010 | \$1286.40 |
| 1862 | \$20.65 | 1900 | \$20.68 | 1937 | \$34.79 | 1974 | \$159.26 | 2011 | \$1662.32 |
| 1863 | \$20.65 | 1901 | \$20.71 | 1938 | \$34.85 | 1975 | \$161.02 | | |
| 1864 | \$20.65 | 1902 | \$20.69 | 1939 | \$34.42 | 1976 | \$124.84 | | |
| 1865 | \$20.65 | 1903 | \$20.67 | 1940 | \$33.85 | 1977 | \$141.71 | | |
| 1866 | \$20.65 | 1904 | \$20.68 | 1941 | \$33.85 | 1978 | \$193.22 | | |
| 1867 | \$20.65 | 1905 | \$20.64 | 1942 | \$33.85 | 1979 | \$306.68 | | |
| 1868 | \$20.65 | 1906 | \$20.62 | 1943 | \$33.85 | 1980 | \$612.56 | | |
| 1869 | \$20.65 | 1907 | \$20.66 | 1944 | \$33.85 | 1981 | \$460.03 | | |
| 1870 | \$20.65 | | | | | | | | |



The Spot Price of Gold ????

The spot price of gold is the official price of gold at any given moment and can vary between various sources of the data. The most common quoted spot price of gold comes from the London P.M. or afternoon fix gold spot price, actually is set during the U.S. morning, about 9:00 A.M. Eastern Standard Time. The London P.M. fix, of all the gold spot prices, is the price at which the world's largest size gold purchases and sales are accomplished on any given day. This is the one price of gold in U.S. dollars which is quoted daily, and familiarly, around the world.

During the U.S. trading day, the spot price is usually based on the latest Comex spot gold price. This is a constantly changing price from the New York markets, and trading goes on until about 2:30 P.M. Eastern time.

ORDERING INFORMATION

ORDERING INSTRUCTIONS

PHONE NUMBER: Toll free 800-900-6463: Local 541-318-1131:
Fax 541-318-1381: Email info@lifestylestore.com

4 WAYS TO ORDER: (1) Mail your order to The Lifestyle Store 2550 NE Hwy 20 Suite 110 Bend, OR 97701. (2) Phone your order in using the toll free number listed above. (3) Order by fax at 541-318-1381. (4) Order via the INTERNET at LifestyleStore.com (secure server for credit card info)

5 WAYS TO PAY FOR YOUR ORDER: (1) Credit Card: Visa, Master Card, Discover, AMX. (2) Cashiers Check or Money Order. (3) Personal Check: Checks received with orders will be deposited upon receipt. (4) PAY-PAL (5) Payment in Gold. All orders are processed assuming they will be shipped complete. However, back orders do occur; these items will be shipped as we receive them . We reserve the right to verify funds with your bank before shipping which may cause a delay. There will be a \$20 service charge for all returned checks.

SALES TAX: California residents add 7.75% sales tax.

PRICING: Prices are subject to change without notice . Current

catalog prices supersede all previous prices.

RETURN PROCEDURE: Returns on damaged shipments require carrier (UPS, POST OFFICE) notification before calling for return authorization. All returns must be made within 30 days.

WARRANTIES ON MERCHANDISE : Products are warranted by the manufacturer. If you have any questions on merchandise care, call the nearest service center of the manufacturer. Neither Lifestyle nor the manufacturer may be held responsible for customer misuse of the product.

SHIPPING COST: The table below can be used to calculate shipping cost. This is for U.P.S. ground service to anywhere in the United States except Hawaii and Alaska, which require air service. We also ship by US Priority mail and by FedEx and UPS air. For shipping cost via air, foreign shipments or shipments to Hawaii and Alaska please call, email or fax the order details and we will promptly calculate the shipping cost for you.

Office Hours: MONDAY-FRIDAY 9 am to 5 pm (Pacific Time)

| | | | | |
|-------------------|------------------|---|--|--|
| NAME: | CHARGE TO: |  | | |
| MAILING ADDRESS: | CARD NUMBER: | | | |
| SHIPPING ADDRESS: | EXPIRATION DATE: | CV Code: | | |
| CITY, STATE, ZIP: | SIGNATURE: | | | |
| PHONE : | ORDER DATE: | | | |

| ITEM # | DESCRIPTION OF ITEM | PRICE EACH | HOW MANY | TOTAL |
|--------|---------------------|------------|----------|-------|
| | | | | |
| | | | | |
| | | | | |
| | | | | |
| | | | | |
| | | | | |
| | | | | |
| | | | | |

THE Lifestyle STORE

2550 NE Highway 20 Suite 110
Bend, Or 97701 541-318-1131

1-800-900-6463

<http://www.LifestyleStore.com>

email:info@lifestylestore.com

| ORDER TOTAL | ADD FOR SHIPPING |
|-------------------|------------------|
| LESS THAN \$10 | \$7.00 |
| \$10 to \$19.99 | \$8.95 |
| \$20 to \$39.99 | \$10.95 |
| \$40 to \$59.99 | \$12.95 |
| \$60 to \$79.99 | \$14.95 |
| \$80 to \$99.00 | \$15.95 |
| \$100 to \$199.00 | \$22.95 |
| \$200 to \$299.95 | \$29.95 |
| \$300 to \$499.95 | \$34.95 |
| \$500 to \$699.95 | \$44.95 |
| \$700 to \$999.95 | \$59.95 |
| \$1000 & over | Free |

| | |
|---|--|
| TOTAL OF GOODS | |
| CALIFORNIA RESIDENTS ADD 7.75% SALES TAX | |
| AMOUNT FOR SHIPPING & HANDLING | |
| ORDER TOTAL | |



We have the tools you need to bring home the gold!



GOLD Wheels
Pages 38-40



Scales
Page 3

Hibankers
Pages 41-46



UV Lights
Page 8-9



Magnifiers
Pages 6-8



Gold Pans
Pages 16-19



Classifiers
Page 20



Metal Detectors
Pages 54-64



Drywashers
Pages 34-36

Rock Tumblers
Pages 24-25



Sluices
Pages 42-48

Dredges
Pages 45-48

THE Lifestyle STORE

COSTCO Shopping Center
2550 NE Highway 20 Suite 110
Bend, Or 97701



Displays
Pages 10-12

